

# Fieldbus System

(For Input/Output)



RoHS

IP65

**New** An **IO-Link** module has been added.

- 2 models (port class A and port class B)
- Diagnosis is possible from the upper level communication.
- The data can be accessed from via PC (setting tool).
- Device parameter setting function, Automatic saving/writing

**New** Supports “System Redundancy S2”

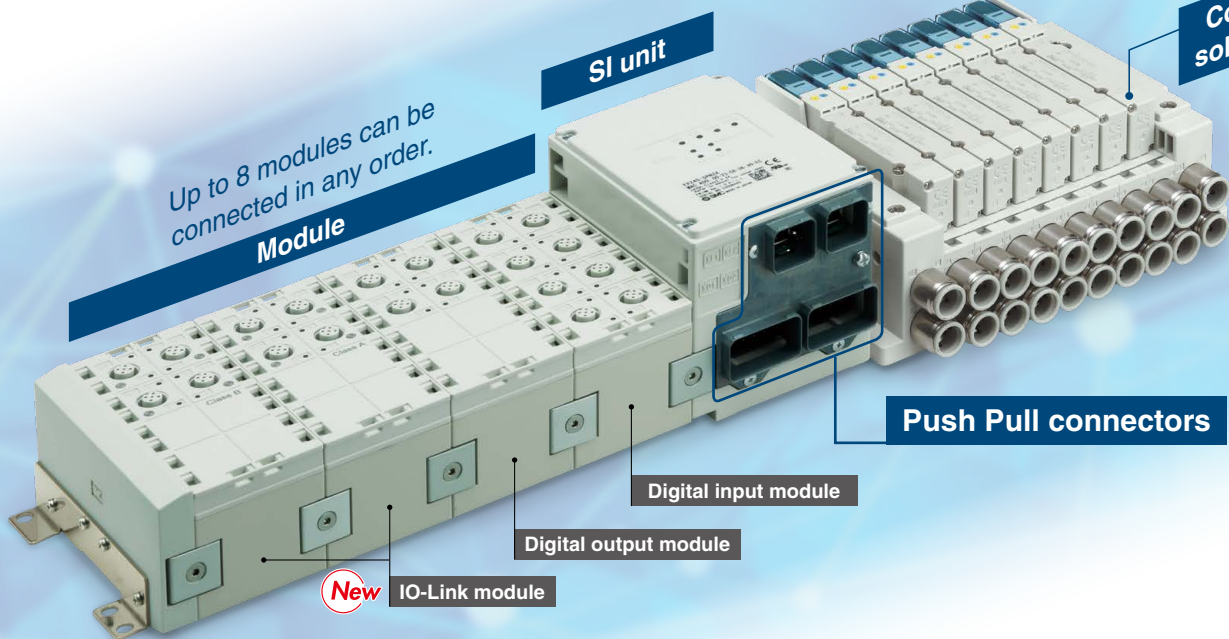

## AIDA\*1 specifications compliant

**Push Pull Connectors** One-touch mounting/removal allows for reduced labor.

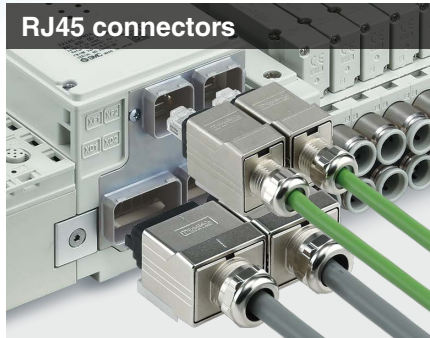
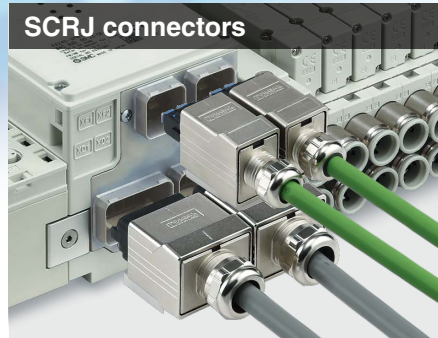

## General-purpose connectors

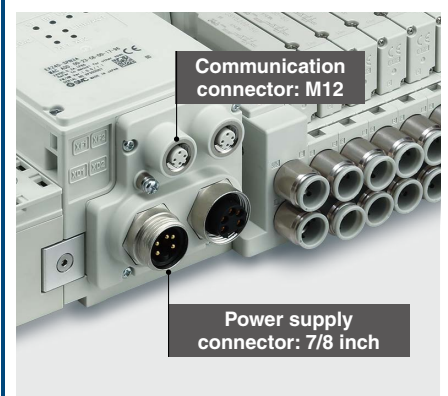

\*1 Automation Initiative of German (Deutschland) Automobile Manufacturers.

## PROFIsafe compatible product



- Product certification obtained by a third party (IEC 61508/62061 SIL 3, ISO 13849 PL e Cat.4)
- Equipped with 8 safety input points and 4 safety output points
- The individual control of safety outputs (valves: 3 zones, modules: 1 zone) is possible.



# EX245 Series



CAT.E02-29B ④

## Compatible with the PROFlenergy energy-saving function

PROFINET



Generally, after factory facilities are shut down, it takes a lot of time to restart them.

PROFlenergy enables PROFINET communication to continue while saving energy by minimizing restart times. When the commands for PROFlenergy energy-saving mode are sent from the I/O controller (PLC) to the I/O device (SI unit), information regarding downtimes is also sent (such as lunch breaks, nighttime, weekends, and holidays).

SMC SI units do not require time for restarting. However, for the connected I/O equipment, such as pressure switches, flow switches, auto switches, and valves, 3 types of energy-saving modes are available for customers to choose from depending on the application.

Mode	Output (Valve/Digital)	Input device (Pressure switch, flow switch, auto switch, etc.)	Input data
Shut down/Clear value mode	OFF	OFF (Power supply)	OFF
Shut down/Hold last value mode	Hold	OFF (Power supply)	Hold
PROCEED mode	Hold	Hold	Hold

## Shared Device function

PROFINET

An I/O module connected to an SI unit can be controlled by multiple I/O controllers (PLC).

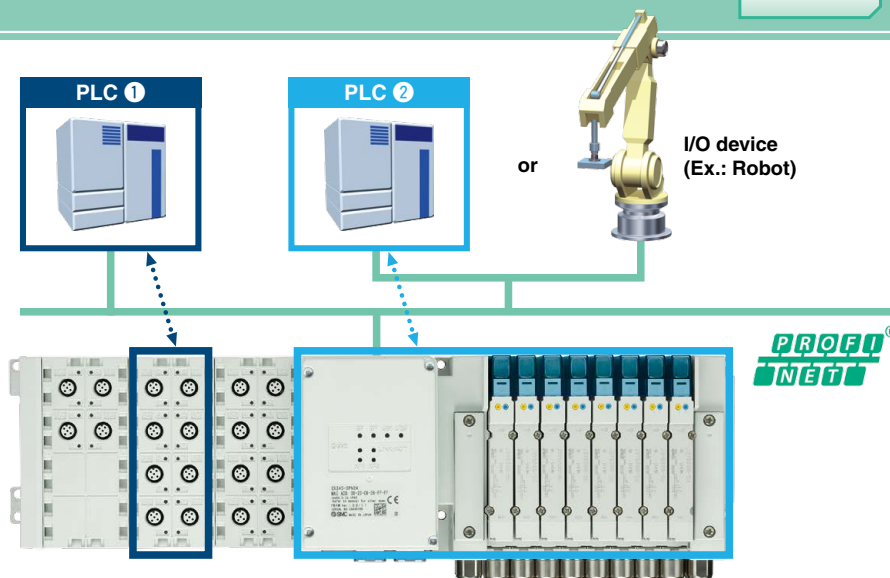

- Information can be shared with up to 3 controllers in addition to the control PLC.
- The cost of the hardware, cables, and installation space can be reduced.

PLC ① to ③: For monitoring  
 PLC ④ : For control

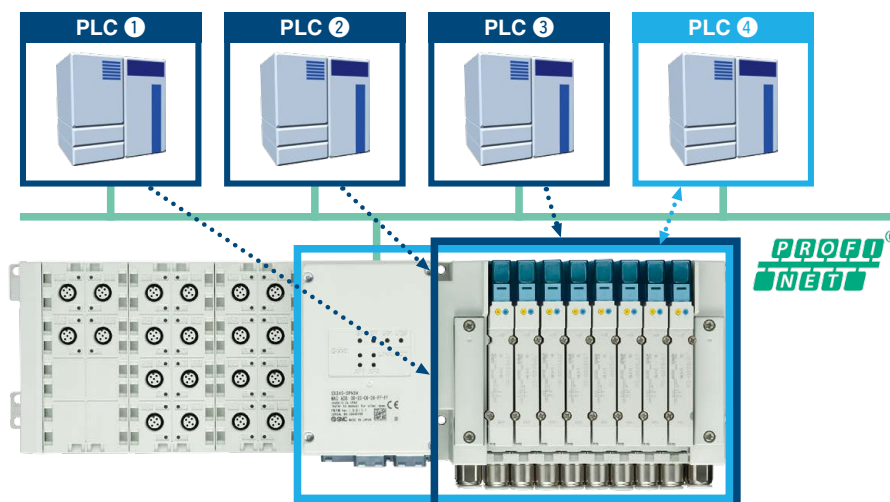

\* The Shared Device function enables an I/O module connected to the I/O device to be controlled by multiple I/O controllers (PLC). The control status can be shared among other I/O controllers. As the function can be used across the entire PROFINET line, the cost for hardware, cables, and installation space can be reduced.

**New System Redundancy S2 function** PROFINET

As the EX245-SPN1/2/3A supports System Redundancy S2, it can continue communication using the backup controller when the primary controller malfunctions. This allows for the prevention of problems caused by unexpected communication interruption.

\* In order to use System Redundancy S2, the PLC must be able to support this function.

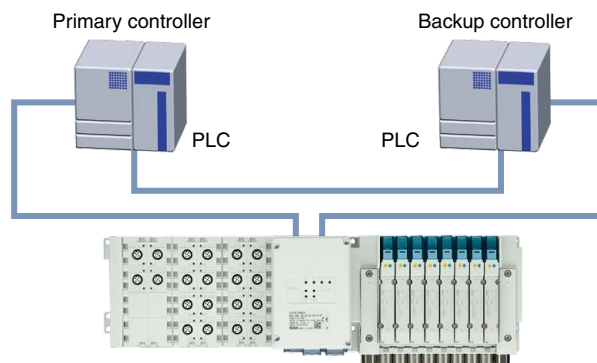

**MRP/MRPD function**

PROFINET PROFIsafe  
\*1 MRP/MRPD    \*2 MRP

**MRP (Media Redundancy Protocol) function**

Communication can be continued even if one of the communication cables in the network is disconnected or damaged. Furthermore, as it is possible to identify the disconnection point quickly, the network disconnection time can be kept within 200 ms.

\* In order to use the MRP function, the PLC must be able to support it.

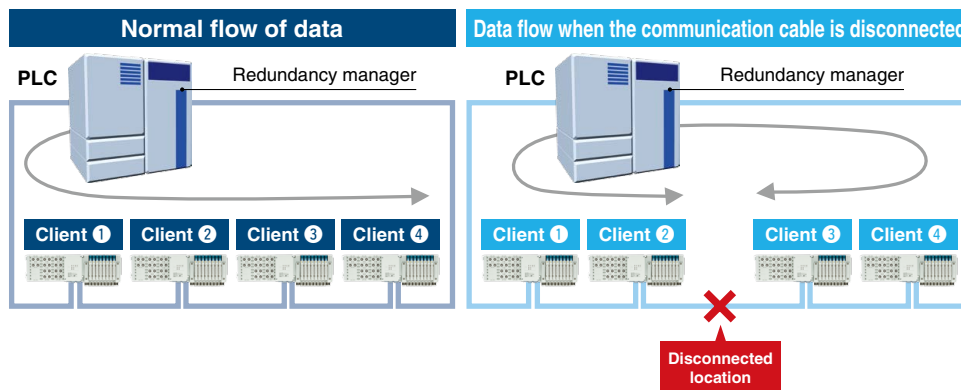

**MRPD (Media Redundancy for planned duplication) function**

It is possible to duplicate routes with a ring topology configured with PROFINET IRT communication. Communication reconnection time is faster than with the MRP function, so communication can be continued without recovery time.

**NET Load Class III compatible** PROFINET

Passed and certified under the highest network load (Class III) specified by PROFINET.

**Fast Start Up function** PROFINET

Time from power ON to communication connection:

**Approx. 10 s**

**0.5 s or less**  
 for the Fast Start Up function

In the case of a tool changer, it takes about 10 seconds for communication to be connected in some products after the power to the device installed on the tool is turned ON.

For products which support the Fast Start Up function, communication can be operational even faster.

\* In order to use the Fast Start Up function, the PLC must be able to support it.

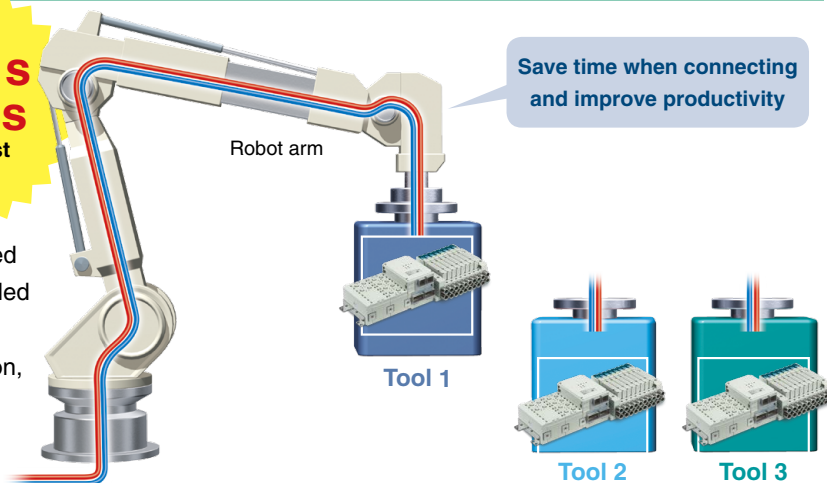



PROFINET

PROFIsafe

## Fiber-optic cable maintenance alarm

\* Available for the EX245-SPN1A and the EX245-FPS1

This feature continuously monitors the received light intensity from the fiber-optic cable and reports it to the PLC. Any loss of intensity is an indicator of damage to the cable, so may give a warning before communication is lost. By using preventative maintenance, you can avoid unexpected shutdowns.

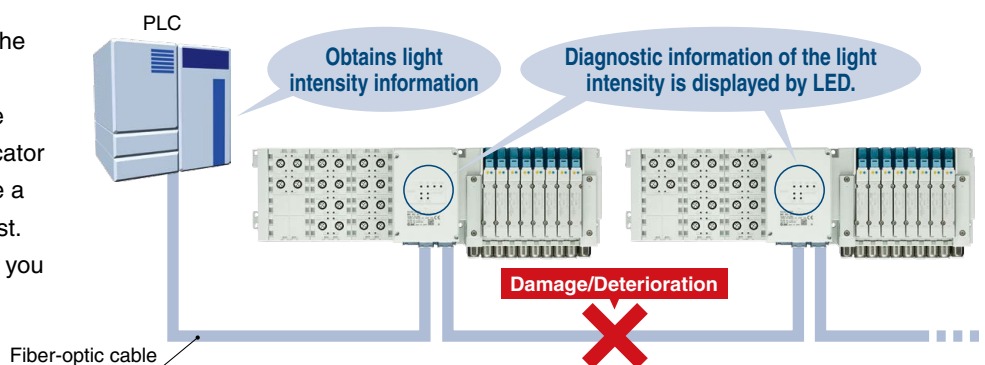

## Supports safety communication (PROFIsafe)

PROFIsafe



PROFIsafe is established as an international standard (IEC 61784-3-3). It is a communication protocol that transmits safety-related data by PROFINET communication and can be used up until safety standards ISO 13849-1 PL e and IEC 61508/IEC 62061 SIL 3.

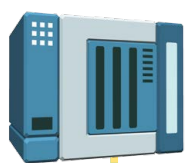

PROFINET/PROFIsafe compatible PLC



The PROFINET/PROFIsafe compatible PLC allows for PROFINET and PROFIsafe compatible SI units to be mixed on one communication line.

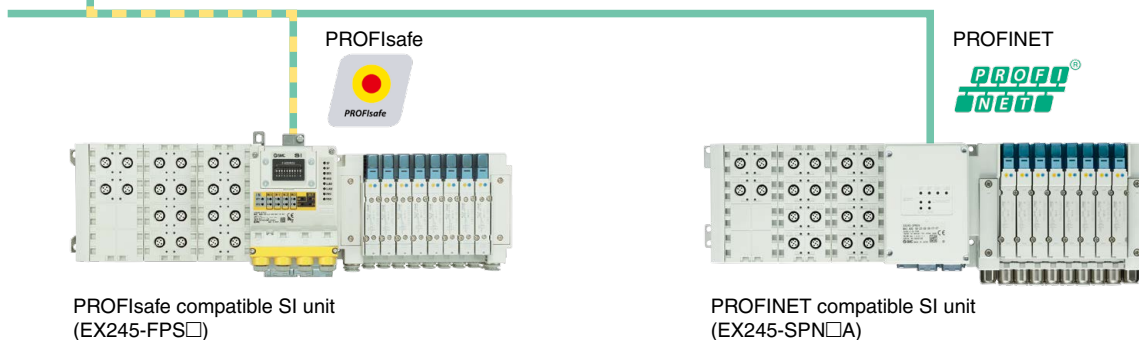

## Compliant with safety standards

PROFIsafe

The aim is to facilitate a safe design (featuring ISO/IEC compliance) of the customer's equipment and facilities. The EX245-FPS□ has been certified under the following categories by a third-party organization (TÜV Rheinland).



IEC 61508/IEC 62061 SIL 3  
ISO 13849 PL e/Cat. 4

• **SIL (Safety Integrity Level)**

A safety integrity level as defined by international standard IEC 61508/62061  
There are 4 levels of safety, with the lowest being SIL 1 and the highest being SIL 4.

• **PL (Performance Level)**

A scale used to define the capability of safety-related parts to perform a safety function as defined by international standard ISO 13849  
There are 5 levels of safety function, with the lowest being PL a and the highest being PL e.



## Built-in web server function, FW (firmware) updates

PROFINET

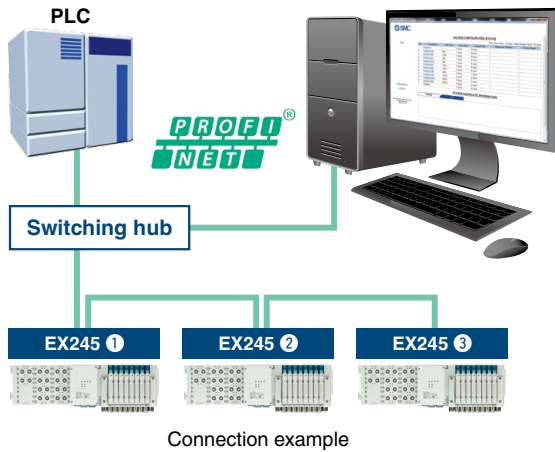

### All products are accessible via PC.

- FW updates
- Status checks
- Forced outputs, etc.

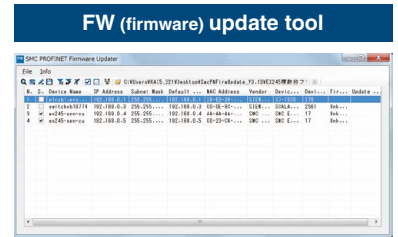
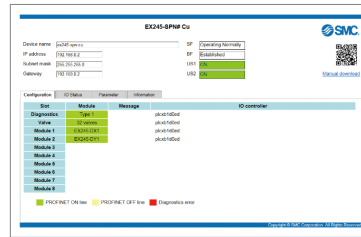

- The status (errors and diagnostic contents) of all products can be checked via web browser.
- Easy operation testing, initial operation checking of equipment, and maintenance without a PLC

- Batch firmware updating for up to 255 units is possible from the Ethernet line.
- Easy to handle future version upgrades

\* If using an IO-Link module, be sure to use the latest GSD file and firmware version available. However, depending on the product's hardware and firmware versions, it may not be possible to use the firmware update function.

## Dual communication and dual power connectors

PROFINET

PROFIsafe

- 2 power connectors and 2 communication connectors are mounted, making daisy-chain connection possible.
- An external branch connector is not necessary. Reduced wiring space
- Loop through current between power connectors: Max. 16 A\*1

\*1 The max. allowable current for the 7/8 inch power supply connector is 10 A. The max. loop through current between connectors is 6 A.

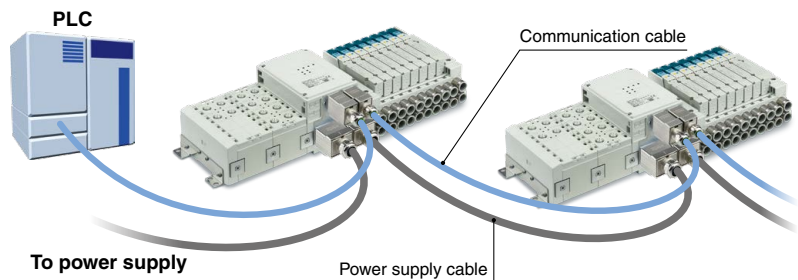

## Modules can be combined flexibly.

PROFINET

PROFIsafe

- Solenoid valve/Digital inputs/outputs/Number of IO-Link ports

	Number of points/ports per each module	Max. number of points/ports per each SI unit
Solenoid valve	—	32 valves
Digital input	16 inputs	128 inputs
Digital output	8 outputs	64 outputs
IO-Link	4-port	32-port

\* Only the EX245-SPN□A (PROFINET) is applicable to the IO-Link module.

- Each module can be connected and removed one by one.
- Up to 8 modules can be connected in any order.

### Connectable Solenoid Valve Series

Series	Flow rate characteristics (42 → 5/3)	Max. number of solenoids	Applicable cylinder size
	C[dm <sup>3</sup> /(s·bar)]		
JSY3000	2.77	32	ø50
JSY5000	6.59		ø80
SY3000	1.6		ø50
SY5000	3.6	24	ø63
VQC2000	3.2		ø63
VQC4000	7.3		ø160

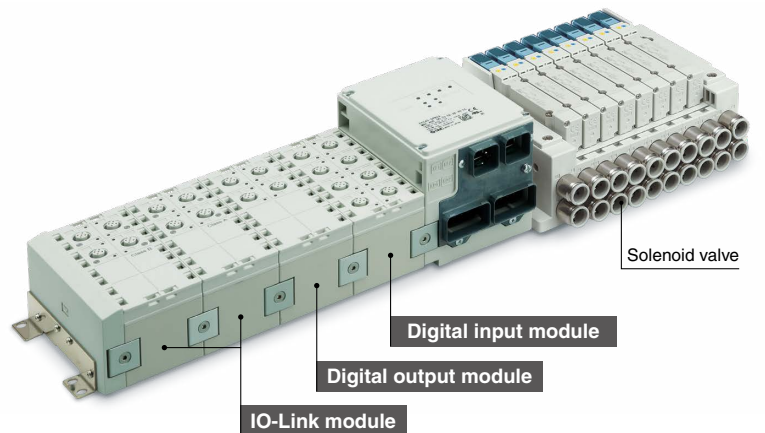

\* For models other than the applicable models, please contact your SMC sales representative.

\* The use of validated products may be required for valve manifolds used in the safety-related parts of equipment which is compliant with international standard ISO 13849. For validated products, please contact your SMC sales representative.

## Safety Output

**PROFIsafe**

The EX245-FPS□ has safety outputs inside the product that can control 3 zones for valves and 1 zone for output modules individually. When the safety switch is turned OFF by directive from the PLC, the voltage supplied to the valve or output module is shut off, and it switches to safe state. The safety switch of this product has two redundancies, one on the 24 V side and the other on the 0 V side. It continuously runs diagnostics. The safety switch is turned OFF in the event of an error detection.

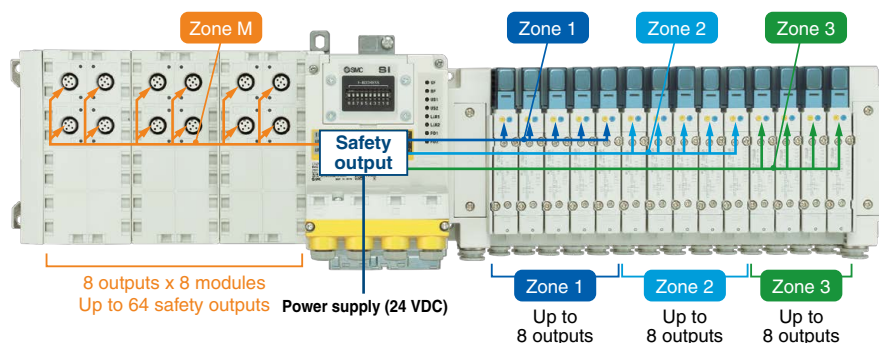

The valve/actuator will not turn ON when the PROFIsafe signal is OFF, even if an ON instruction is given via PROFINET signal. Only when both PROFINET and PROFIsafe instruct the device to turn ON will the valve/actuator turn ON.

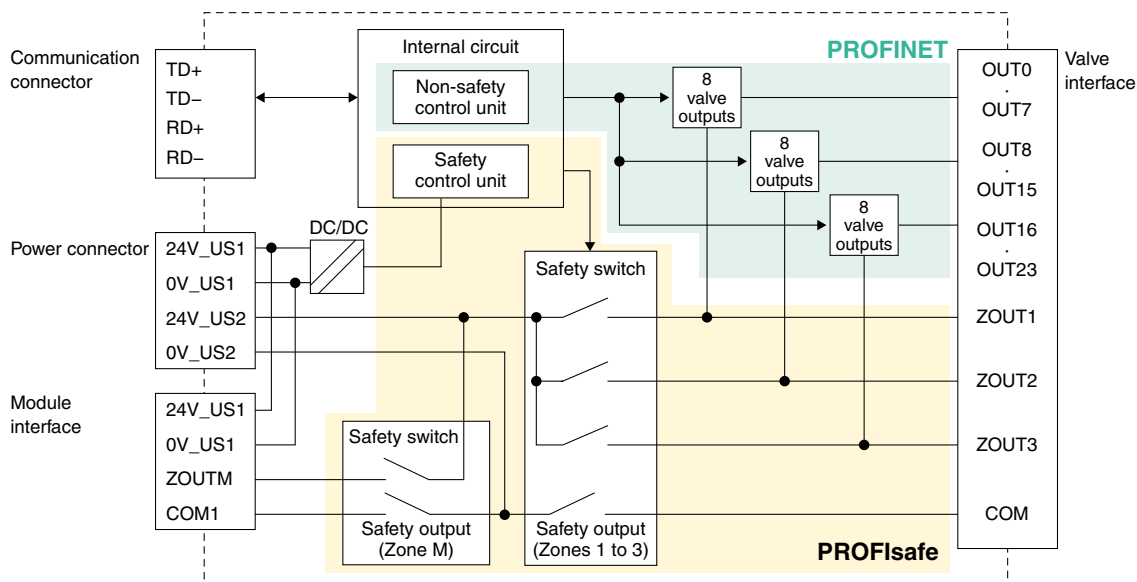

### **⚠ Safety Definition**

The safe state of the EX245-FPS□ is a condition in which the safety output described above is turned OFF to shut off the supply of power to the valve manifold. This product does not cover valve manifolds that are being used in connection with this product or the safety function and safe state of electric/air equipment that includes a peripheral circuit.

## Safety Input

**PROFIsafe**

The EX245-FPS□ is equipped with safety inputs. The safety inputs of this product can connect to components (e.g. laser scanners, light curtains, etc.) that are compatible with the safety inputs. The safety input can be loaded in 2 ways:

- Single channel (1 out of 1): 8 safety inputs (SIL 2/PL d)
- Dual channel (1 out of 2): 4 safety inputs (SIL 3/PL e)

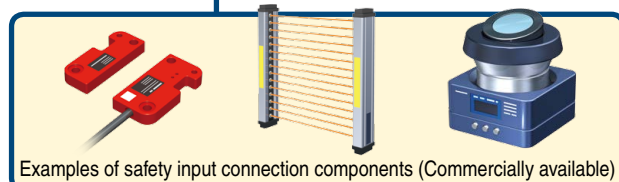
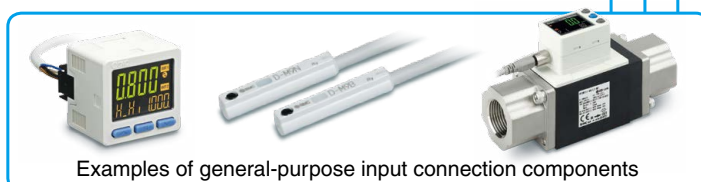
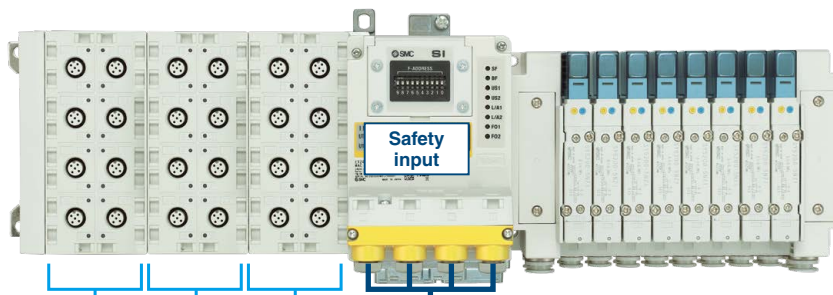

# Safety Input/Output Construction Example

**PROFIsafe**

## When using a PROFIsafe compatible SI unit

- Separate safety input/output units (commercially available) are not required. (Space saving)
- Multi-zone safety outputs can be individually controlled.

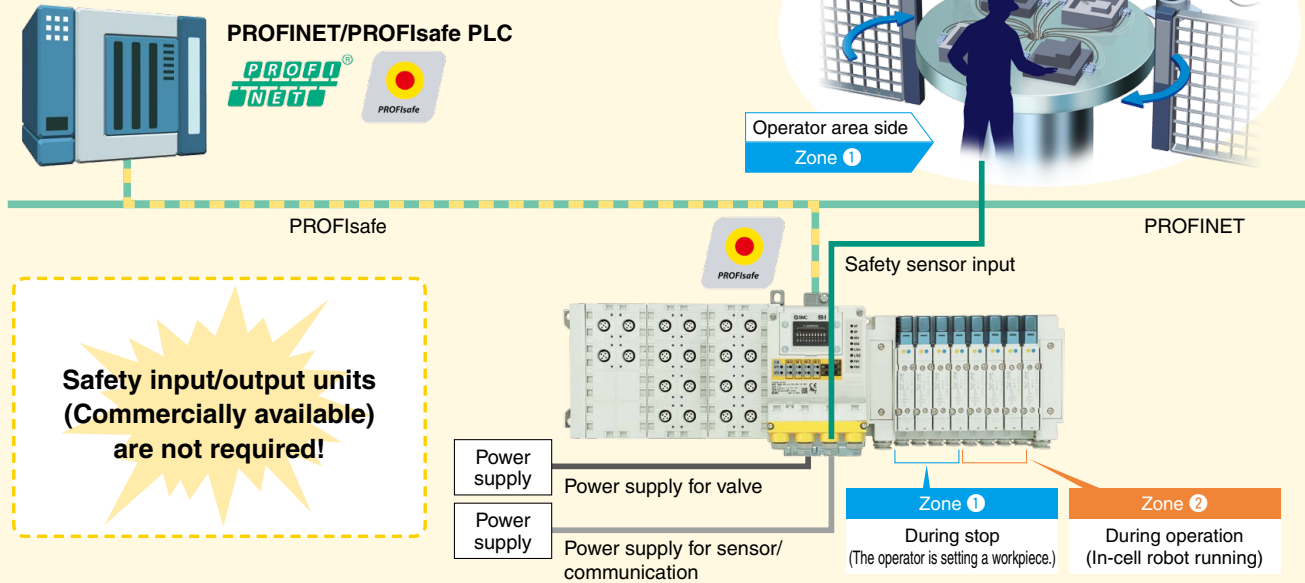

## When using a PROFINET compatible SI unit

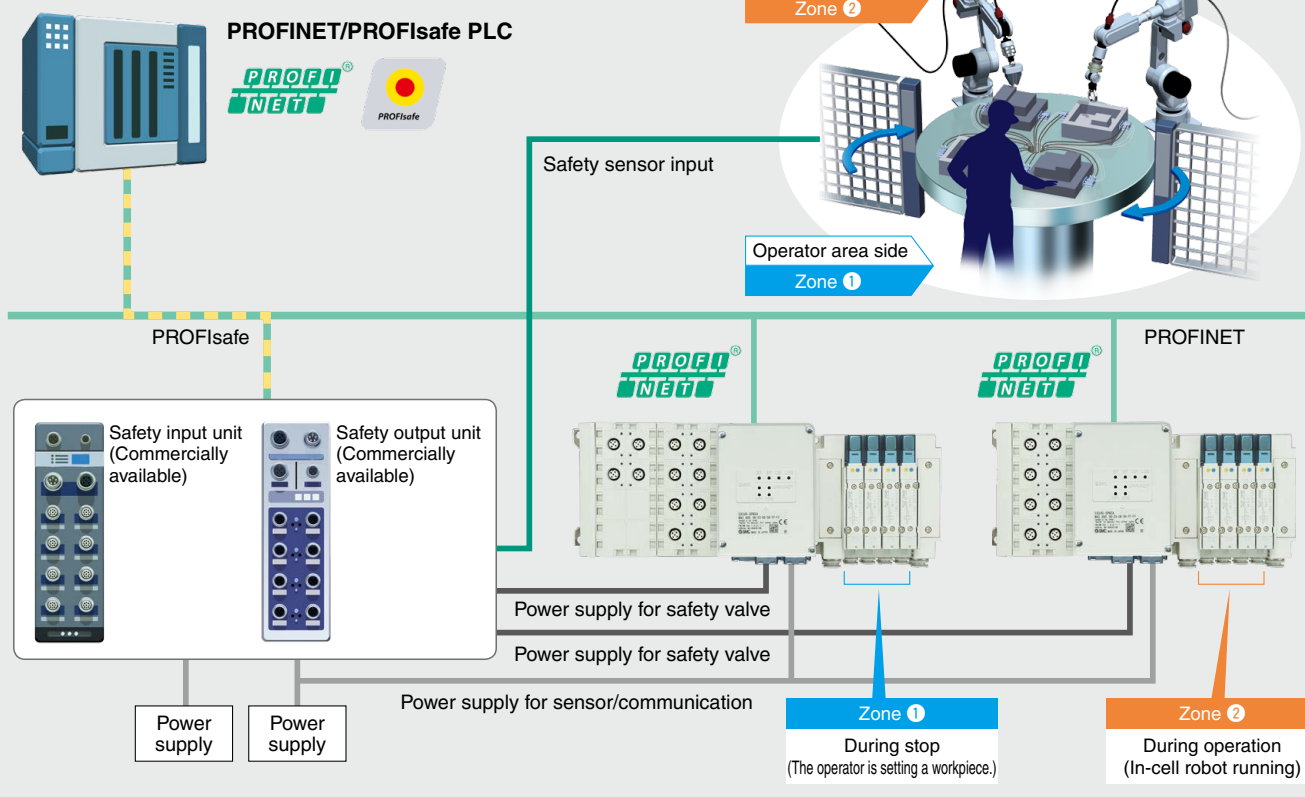

## ⚠ Safety of the machine or system

The manufacturer of the machine/system and its user are responsible for the safety of the machine/system. Use of the EX245-FPS□ requires machine/system safety concepts which are in accordance with the corresponding directives and standards, safety function validation, and hazard and risk analysis. Target SILs (IEC 61508/62061 compliance) and performance levels/categories (ISO 13849 compliance) are determined based on the risk analysis. For more information, refer to the "Safety of the machine or system" section in the operation manual of the EX245-FPS□.



# IO-Link

IO-Link is a communication technology for sensors and actuators that is an international standard, IEC 61131-9.

This technology is used to send/receive device information such as manufacturer, product part number, parameters, and diagnostic data, as well as the control data including ON/OFF signals and measured values of the sensor, by connecting the IO-Link master and device in a 1:1 configuration.

IO-Link enables condition monitoring and error detection of the sensor and equipment, and it can contribute to the reduction of startup labor and recovery time and the realization of preventive and predictive maintenance.

### Reduced design and startup labor

- Batch setting of device parameters from the upper level
- Remote check of device information
- Detection and remote unified check of device misconnection/non-connection

### Minimum recovery time due to error detection

- Early detection of location where problem is occurring via communication
- Early obtaining of information on problem phenomenon via communication
- Early recovery during product replacement (automatic setting of device parameters)

### Preventive and predictive maintenance through condition monitoring

- Monitors changes in measured values of a sensor during signal ON/OFF
- Monitors the number of device operations and automatically notifies when the set number of operations has been exceeded
- Remote monitoring of device and equipment conditions via communication

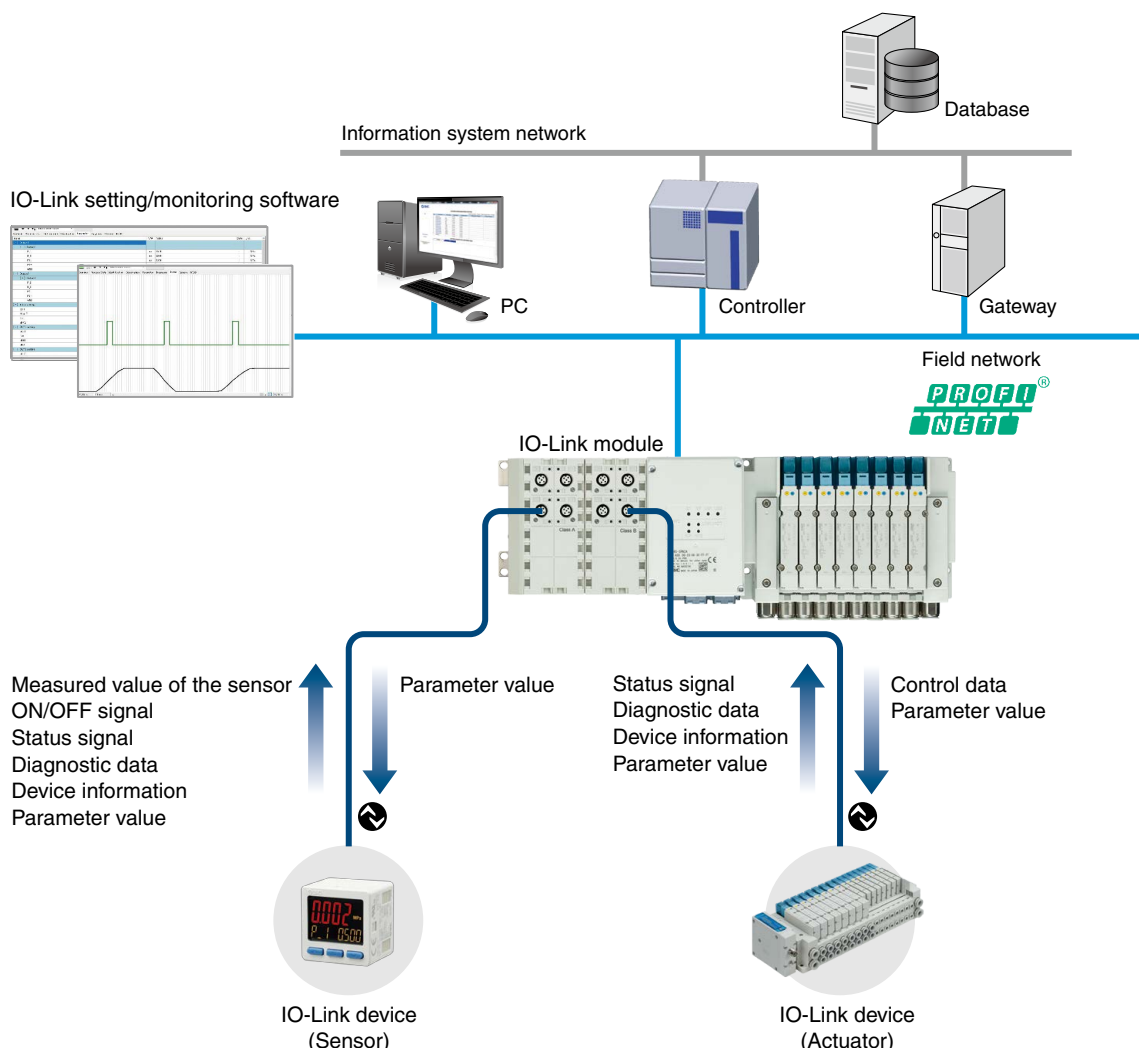

## IO-Link System Configuration

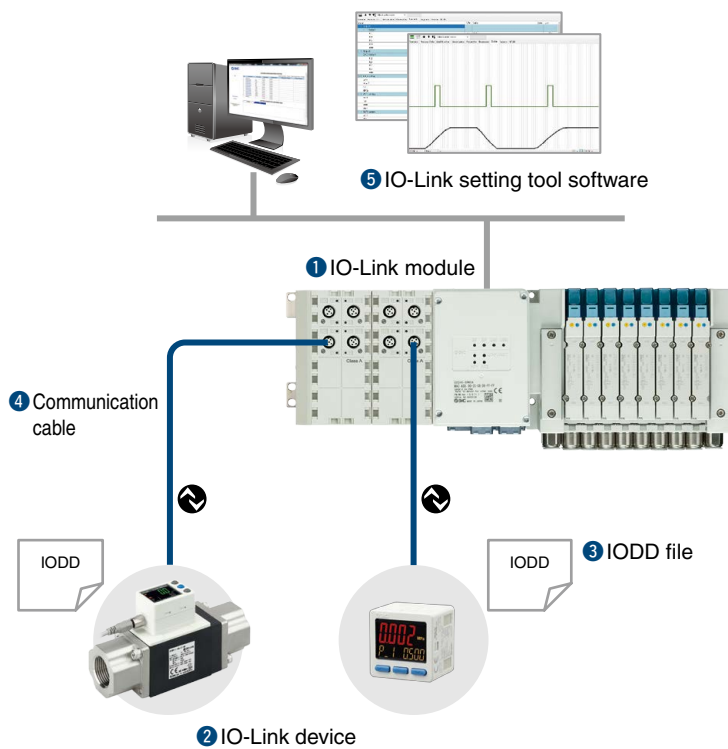

### 1 IO-Link module

- Acts as a gateway between the IO-Link communication and the upper level communication

### 2 IO-Link device

- A sensor/actuator connecting to an IO-Link module in a 1:1 configuration

### 3 IODD file

- A file in which device properties and parameters are described
- Registered to the setting tool
- Provided by the device manufacturer

### 4 Communication cable

- A 4-wire or 5-wire general-purpose cable that is the same as the existing sensor cable (Unshielded cable)
- Max. cable length: 20 m

### 5 IO-Link setting tool software

- Software for the setting and monitoring of an IO-Link module/device\*1

\*1 A setting tool compatible with the IO-Link master of every manufacturer is used for the SMC EX245 series IO-Link module. (IO-Link Device Tool V5 manufactured by TMG Technologie und Engineering, Germany)

## IO-Link Interface

The connecting part between the IO-Link module and the device is called a “port.” Each port can be switched between “IO-Link mode” for digital communication and “standard I/O mode” for conventional contact input/output.

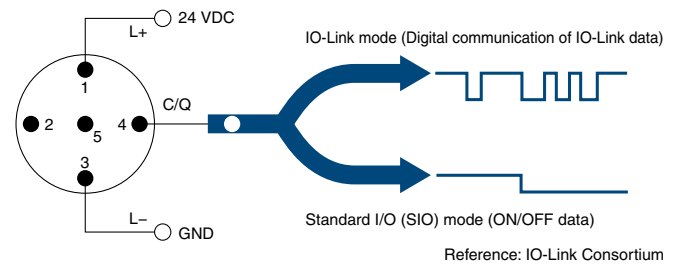

## 2 types of interfaces

There are two methods for power supply: one is for sensors, and the other is for actuators.

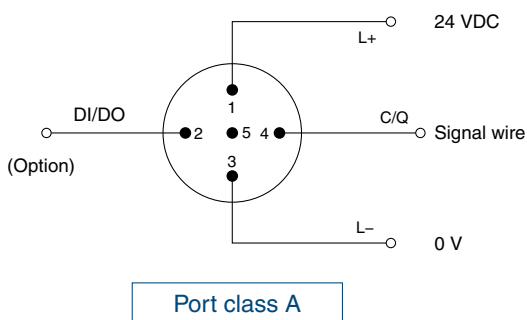

The control power supply wire and signal wire can be connected with one cable. (Mainly for sensors)

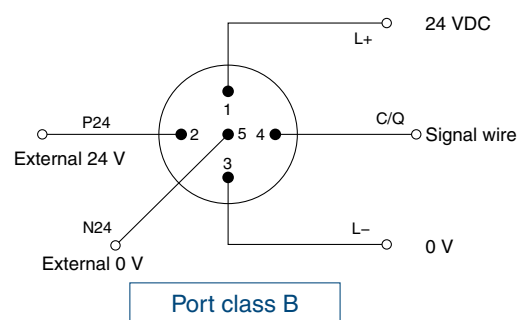

The control power supply wire, external power supply wire, and signal wire can be connected with one cable. (Mainly for actuators)

## IO-Link Module

### The mixed use of digital and IO-Link modules is possible.

Digital input/output modules, Class A and IO-Link module can be mixed, and up to 8 units can be connected in any order.

### Supports 4 ports

4 IO-Link devices can be connected.

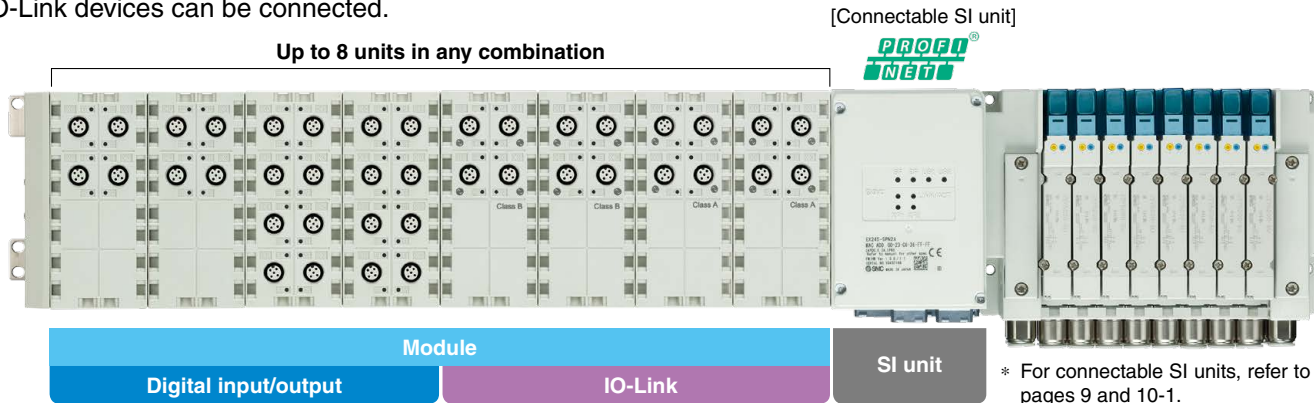

### Supports both port class A and port class B

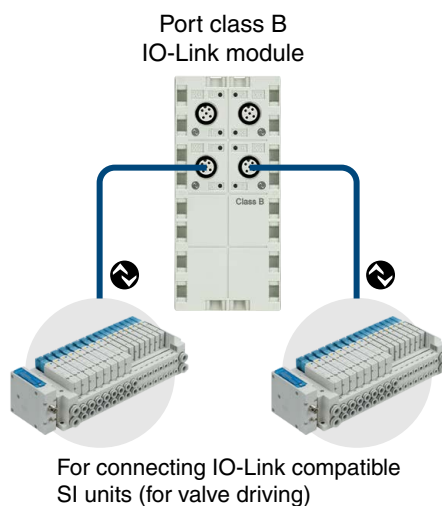
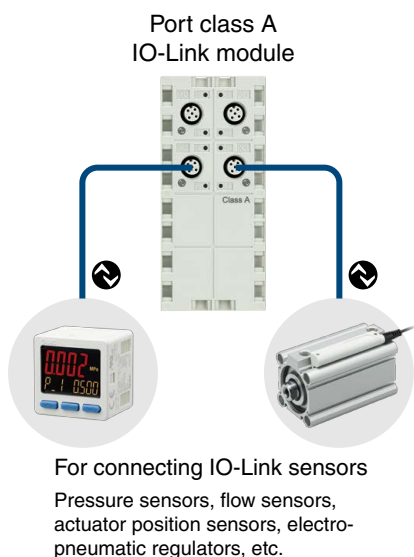

\* A special wiring Y branch connector for port class A electrical power supply is available. For details, refer to Accessories ⑧ on page 18.

### The data can be accessed from via PC (setting tool).

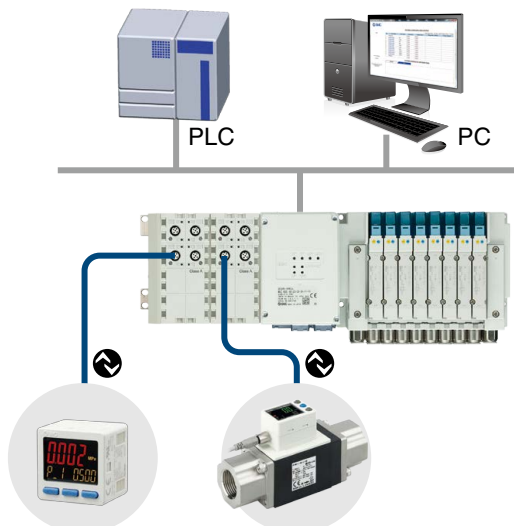

Setting screen

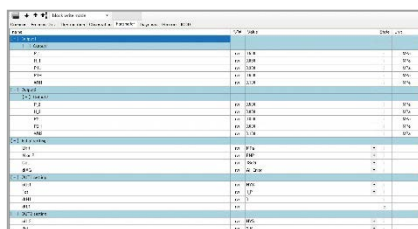

Monitoring screen



The setting and monitoring of the IO-Link module and device are possible via PC, without using the PLC.

- Process data
- Device parameters, IO-Link module parameters
- IO-Link module information, Device information
- Port diagnosis, Device diagnosis

\* The PC setting tool is an IO-Link device tool manufactured by Technologie Management Gruppe (hereinafter referred to as TMG). It can be downloaded for free from the TMG website, however, for usage beyond 30 days, a license key is required.



# IO-Link Module

PROFINET

## ■ Diagnosis function

**Diagnosis is possible from the upper level communication.**

IO-Link module diagnostic information can be obtained via PLC program or PC (web browser).  
 Device diagnostic information can be obtained via PC (setting tool).

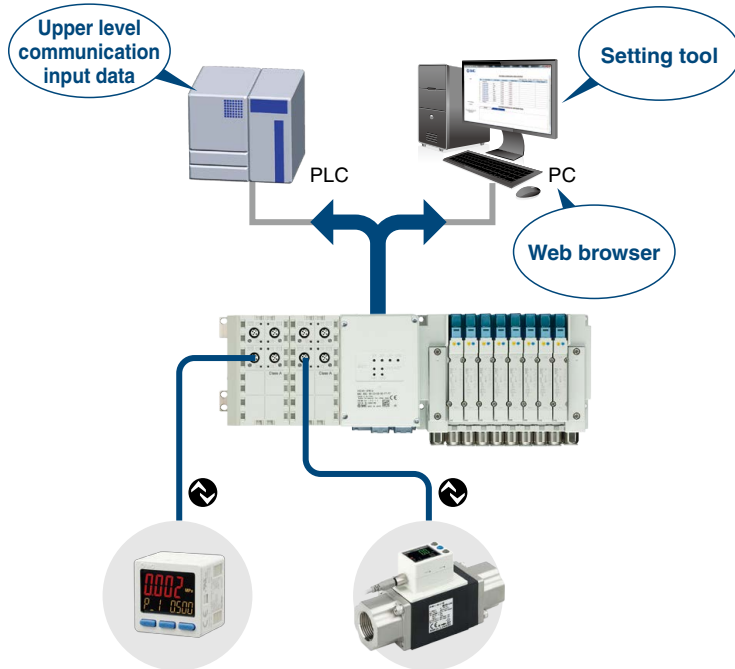

Items of IO-Link module diagnosis
Detection of port short-circuit
Detection of non-connected device
Detection of misconnected device (check error)
Notification of port misconfiguration (excessively large input/output data)
Conditions of diagnostic event (port, device)
Items of device diagnosis
Diagnostic results (problem phenomenon) received from devices are shown in event codes.

## ■ Device parameter setting function, Automatic saving/writing

**The parameter setting of devices is possible from the upper level communication.**

Parameter setting is possible via PC (setting tool).  
 It is also possible to use output data or message data via PLC program.

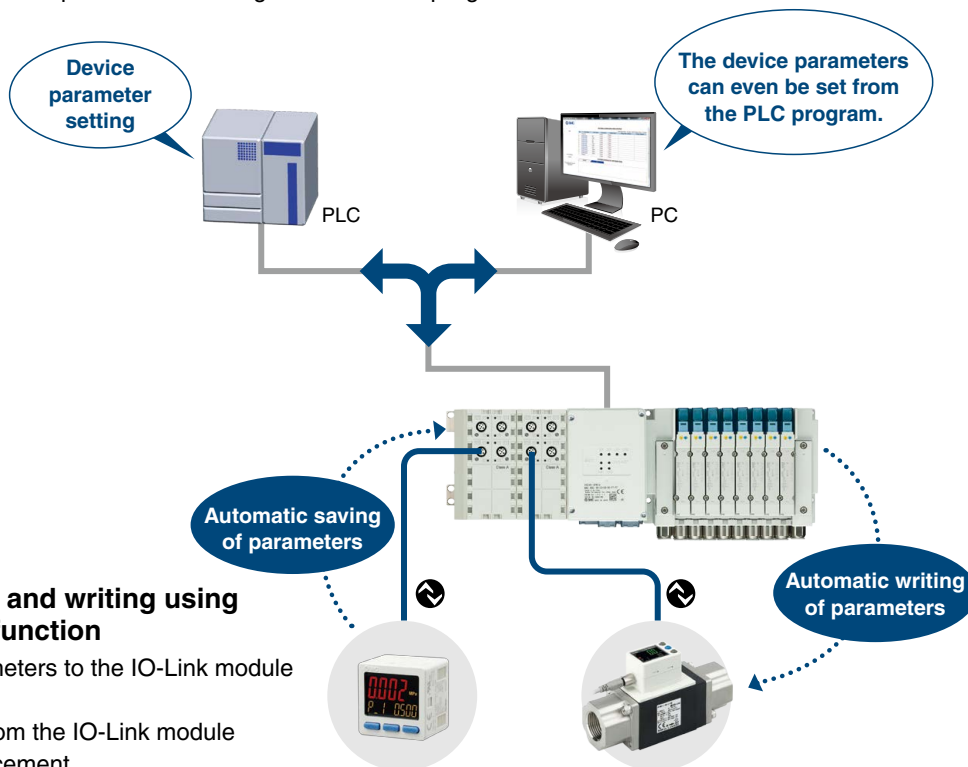

### Automatic saving and writing using the data storage function

- Saves device parameters to the IO-Link module automatically
- Automatic writing from the IO-Link module during device replacement

# CONTENTS

## Fieldbus System (For Input/Output) **EX245 Series**

**SPN1A (SCRJ)**

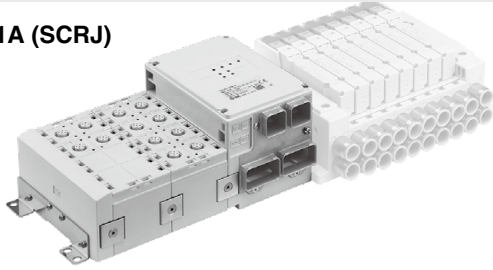

**SPN2A (RJ45)**

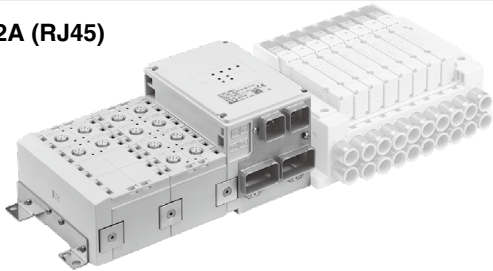

**SPN3A (M12)**

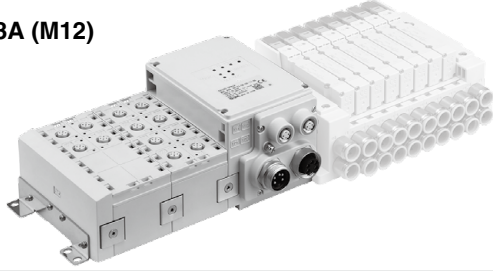

**FPS1 (SCRJ)**

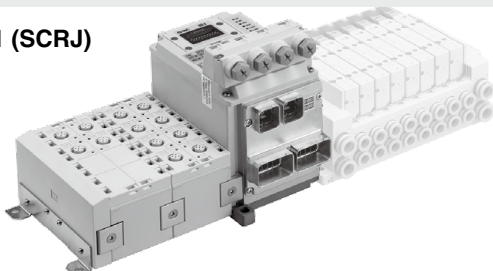

**FPS2 (RJ45)**



**FPS3 (M12)**



**Construction** ..... p. 8  
**How to Order** ..... p. 8  
**Specifications** ..... p. 9  
**Dimensions/Parts Description** ..... p. 11  
**Assembly Examples** ..... p. 14

**Accessories**

① Seal Cap ..... p. 15  
 ② Marker ..... p. 15  
 ③ Joint Pack ..... p. 15  
 ④ 7/8 Inch Connector and Related Parts..... p. 15  
 ⑤ Communication Cable/Connector ..... p. 16  
 ⑥ Field-wireable Communication Connector ..... p. 17  
 ⑦ I/O Cable with Connector, I/O Connector ..... p. 18

**Specific Product Precautions** ..... p. 19

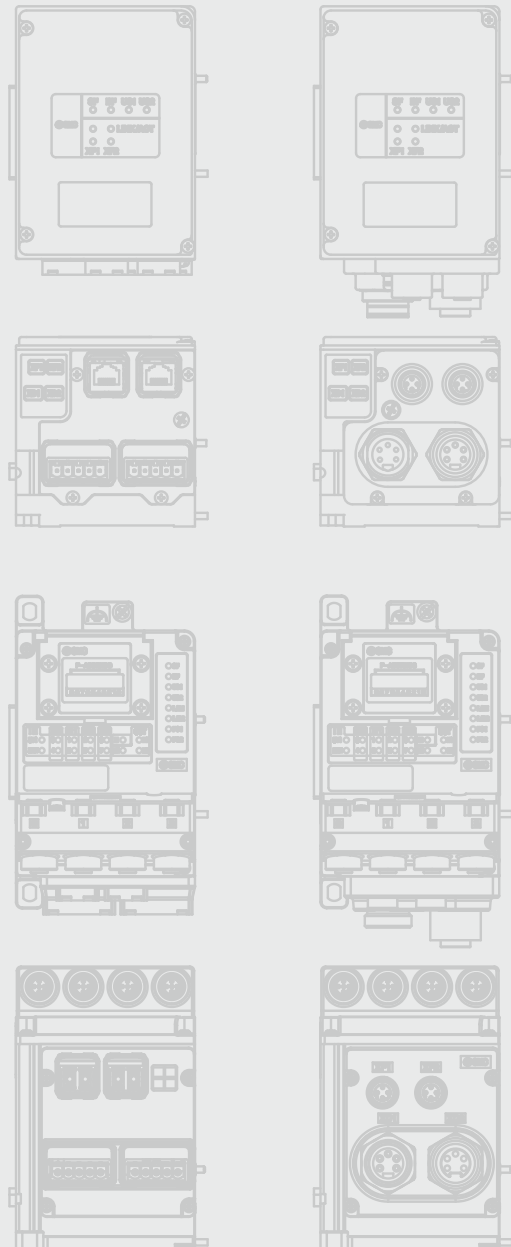

# Fieldbus System For Input/Output



RoHS

IP65

# EX245 Series

## Construction

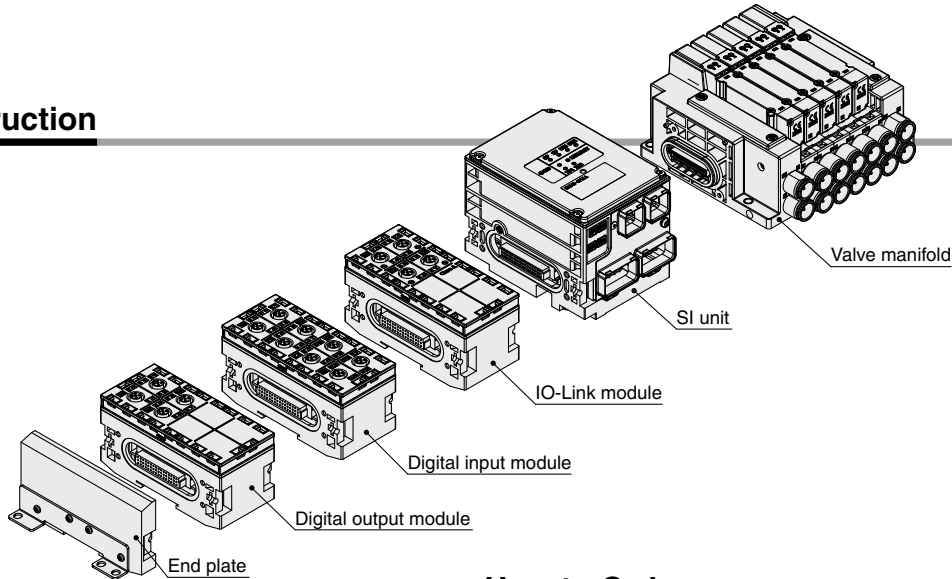

## How to Order

### SI Unit

## EX245-SPN1A

#### Connector type

Symbol	Protocol	Communication connector	Power supply connector
SPN1A	PROFINET	Push Pull connector (SCRJ): 2 pcs.	Push Pull connector (24 V): 2 pcs.
SPN2A		Push Pull connector (RJ45): 2 pcs.	Push Pull connector (24 V): 2 pcs.
SPN3A		M12 connector (4-pin, Socket, D-coded): 2 pcs.	7/8 inch connector (5-pin, Plug): 1 pc. 7/8 inch connector (5-pin, Socket): 1 pc.
FPS1	PROFIsafe	Push Pull connector (SCRJ): 2 pcs.	Push Pull connector (24 V): 2 pcs.
FPS2		Push Pull connector (RJ45): 2 pcs.	Push Pull connector (24 V): 2 pcs.
FPS3		M12 connector (4-pin, Socket, D-coded): 2 pcs.	7/8 inch connector (5-pin, Plug): 1 pc. 7/8 inch connector (5-pin, Socket): 1 pc.

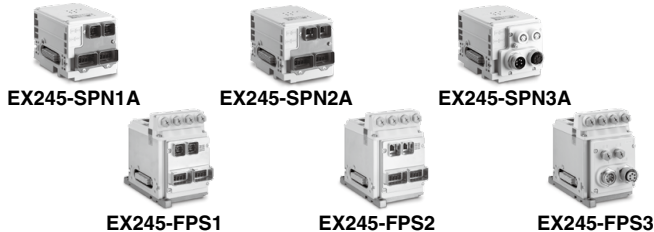

### Digital Input Module

## EX245-DX1



#### Digital input module specification

<b>DX1</b>	Digital input (16 inputs)
------------	---------------------------

### Digital Output Module

## EX245-DY1



#### Digital output module specification

<b>DY1</b>	Digital output (8 outputs)
------------	----------------------------

### End Plate

## EX245-EA2-1

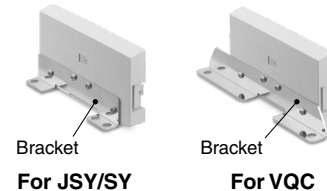

#### Bracket

1	General-purpose
2	Without bracket
3	For JSY/SY (Only for EX245-SPN□A)
4	For VQC4000 (Only for EX245-SPN□A)
5	For VQC2000 (Only for EX245-SPN□A)

### IO-Link Module

## EX245-LA1



#### IO-Link module specification

<b>LA1</b>	Class A (4-port)
<b>LB1</b>	Class B (4-port)

- \* For the EX245-EA2-3/4/5, only the EX245-SPN□A can be connected. The bracket is adjusted according to the mounting hole pitch of the valve manifold.
- \* When using the EX245-FPS□, please select the EX245-EA2-1 or 2.

- \* Refer to the **Web Catalog** for valve manifold part numbers. If you are considering using a manifold valve compatible with PROFIsafe, be sure to check with your SMC sales representative prior to ordering.



# EX245 Series

## Specifications

### Common for All Units/Modules

Item	Specifications
Operating temperature range	Operating: -10 to 50°C, Stored: -20 to 60°C (No condensation)
Operating humidity range	Operating, Stored: 35 to 85% RH (No condensation)
Withstand voltage	500 VAC for 1 minute between external terminals and FE
Insulation resistance	500 VDC, 10 MΩ or more between external terminals and FE
Enclosure	IP65 (Manifold assembly, With seal cap)
Standards	CE/UKCA marking (EMC directive/RoHS directive), UL (CSA)



EX245-SPN1A



EX245-SPN2A



EX245-SPN3A



EX245-FPS1



EX245-FPS2



EX245-FPS3

### SI Unit (EX245-SPN□A) PROFINET

Model		EX245-SPN1A	EX245-SPN2A	EX245-SPN3A
Communication	Protocol	PROFINET		
	Device type	PROFINET IO		
	Communication speed	100 Mbps full duplex		
	Configuration file*1	GSD file		
Electrical	Applicable function	MRP function, MRPD function, Fast Start Up function, Shared Device function, PROFenergy function, Web server function, FW update function, Conformance Class C, NET Load Class III Fiber-optic cable maintenance alarm		
	Internal current consumption (US1)	300 mA or less	200 mA or less	—
	Loop through current between power connectors	16 A	—	6 A
Output	Operating voltage/ Max. current	24 VDC +20%, -15%/6 A	—	—
	Max. current	24 VDC +20%, -15%/4 A	—	—
General	Output type	Source/PNP (Negative common)		
	Number of outputs	32 outputs		
	Load	Solenoid valve with surge voltage suppressor of 24 VDC, 1 W or less (SMC)		
	Power supply	24 VDC, 2 A		
General	Protection	Short-circuit protection		
	Max. number of modules	8		
	Max. number of digital inputs	128		
	Max. number of digital outputs	64		
	Applicable modules	Input module, Output module, IO-Link module		
	Weight	465 g	—	540 g

\*1 The configuration file can be downloaded from the SMC website: <https://www.smcworld.com>

### SI Unit (EX245-FPS□) PROFINET, PROFIsafe

Model		EX245-FPS1	EX245-FPS2	EX245-FPS3
Communication	Protocol	PROFINET, PROFIsafe		
	Device type	PROFINET IO		
	Communication speed	100 Mbps full duplex		
	Applicable function	MRP function, Conformance Class C, NET Load Class I Fiber-optic cable maintenance alarm		
Electrical	Internal current consumption (US1)	350 mA or less	300 mA or less	—
	Loop through current between power connectors	16 A	—	10 A
	Operating voltage/ Max. current	24 VDC +20%/-15%, 6 A	—	—
Safety input	Max. current	24 VDC +20%/-15%, 4 A (Excludes valves)		
	Number of inputs	Dual channel: 4 inputs, Single channel: 8 inputs		
	External supply voltage	24 VDC +20%/-15%		
	Max. supply current	UT1: 2 A, UT2: 1 A		
	Cross-circuit detection	Yes		
	Over current/Short-circuit detection function	Yes		
	Input type	PNP		
	ON voltage	11 to 30 V		
	OFF voltage	-3 to 5 V		
	Input current (at 24 VDC)	Typ. 3.8 mA		
Safety output	Input characteristics	Type 3 (IEC 61331)		
	Number of safety outputs	Valve side	3 zones	—
		Module side	1 zone	—
	Max. current	Valve side	1.5 A (Total of 3 zones)	
		Module side	4 A	
	Short-circuit protection	Yes		
Output	Power supply source	US2		
	Output type	PNP		
	Number of outputs	8 outputs/zone, Total of 24 outputs		
	Load	Solenoid valve with surge voltage suppressor of 24 VDC, 1 W or less (SMC)		
General	Protection	Short-circuit protection		
	Power supply	24 VDC, 1.5 A		
	Max. number of modules	8		
	Max. number of digital inputs	128		
	Max. number of digital outputs	64		
General	Applicable modules	Input module, Output module		
	Weight	1,100 g	—	1,200 g

\* The configuration file can be downloaded from the SMC website: <https://www.smcworld.com>

## Specifications

### Manifold Wiring Example

\* For details on input/output module connection, refer to the operation manual.

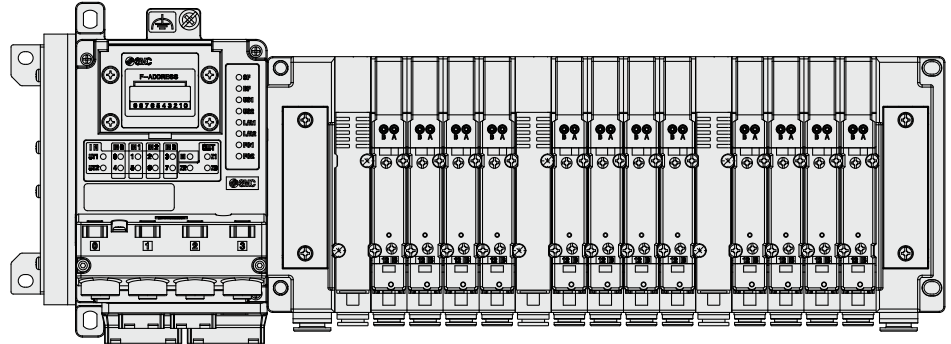

### <Valve interface pin arrangement>

Pin no.	Valve zone	Signal name	Function
1	Common	M OUT1	Common 0 V
2			
3	Zone 1	Z OUT1	Zone 1: Safety output
4		SOL0	Output 0 (Output is available only when Zone 1 is turned ON.)
⋮		⋮	⋮
11		SOL7	Output 7 (Output is available only when Zone 1 is turned ON.)
12	Zone 2	Z OUT2	Zone 2: Safety output
13		SOL8	Output 8 (Output is available only when Zone 2 is turned ON.)
⋮		⋮	⋮
20		SOL15	Output 15 (Output is available only when Zone 2 is turned ON.)
21	Zone 3	Z OUT3	Zone 3: Safety output
22		SOL16	Output 16 (Output is available only when Zone 3 is turned ON.)
⋮		⋮	⋮
29		SOL23	Output 23 (Output is available only when Zone 3 is turned ON.)

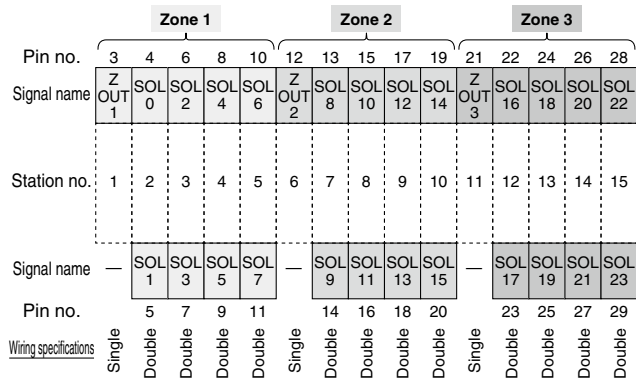

The stations corresponding to the safety outputs (Z OUT n) are configured by single wiring.



EX245-DX1

### Digital Input Module

Model		EX245-DX1
Input	Input type	PNP
	Input connector	M12 (5-pin) socket*1
	Number of inputs	16 inputs
	Supplied voltage	24 VDC
	Max. supplied current	0.5 A/Connector, 2 A/Module
	Protection	Short-circuit protection
	Input current (at 24 VDC)	Typ. 4.5 mA
	ON voltage	11 to 30 V
	OFF voltage	-3 to 5 V
Internal current consumption	50 mA or less	
Weight	280 g	

\*1 An M12 (4-pin) connector can also be connected.



EX245-DY1

### Digital Output Module

Model		EX245-DY1
Output	Output type	PNP
	Output connector	M12 (5-pin) socket*1
	Number of outputs	8 outputs
	Supplied voltage	24 VDC
	Max. load current	0.5 A/Output, 2 A/Module
	Protection	Short-circuit protection
Current consumption	50 mA or less	
Weight	280 g	

\*1 An M12 (4-pin) connector can also be connected.

# EX245 Series

## Specifications



EX245-LA1



EX245-LB1



For JSY/SY

For VQC

EX245-EA2-□

### IO-Link Module

Model		EX245-LA1	EX245-LB1
<b>IO-Link version</b>		Version 1.1	
<b>IO-Link port class</b>		Class A	Class B
<b>Communication speed</b>		COM1 (4.8 kBaud) COM2 (38.4 kBaud) COM3 (230.4 kBaud) * Changes automatically according to the connected device	
<b>Number of IO-Link ports</b>		4	
<b>Compatible SI unit</b>		EX245-SPN1A, EX245-SPN2A, EX245-SPN3A	
<b>Max. supply current</b>	<b>Device power supply (L+)</b>	0.5 A/Connector (2 A/Unit)	0.5 A/Connector (1 A/Unit)
	<b>External power supply (P24)</b>	—	1.6 A/Connector (3 A/Unit)
<b>Input</b>	<b>Pin no.</b>	2	4
	<b>Input type</b>	PNP	
	<b>Protection</b>	Short-circuit protection	
	<b>Rated input current</b>	Approx. 2.5 mA	Approx. 5.8 mA
	<b>ON voltage</b>	13 V or more	
<b>Output</b>	<b>OFF voltage</b>	8 V or less	
	<b>Pin no.</b>	4	
	<b>Output type</b>	PNP	
	<b>Max. load current (C/Q line)</b>	0.25 A/Output (Supplied from the power supply for control/input)	
<b>Protection</b>		Short-circuit protection	
<b>Current consumption</b>		50 mA or less	
<b>Weight</b>		280 g	

### End Plate

Model	EX245-EA2-1	EX245-EA2-2	EX245-EA2-3	EX245-EA2-4	EX245-EA2-5
<b>Bracket</b>	Yes (General-purpose)	No	Yes (Mounting hole for JSY/SY)	Yes (Mounting hole for VQC4000)	Yes (Mounting hole for VQC2000)
<b>Weight</b>	120 g	80 g	120 g	150 g	120 g

\* For the EX245-EA2-3/4/5, only the EX245-SPN□A can be connected. The bracket is adjusted according to the mounting hole pitch of the valve manifold.

\* When using the EX245-FPS□, please select the EX245-EA2-1 or 2.





# EX245 Series

## Dimensions/Parts Description

### SI Unit

#### EX245-SPN1A/2A

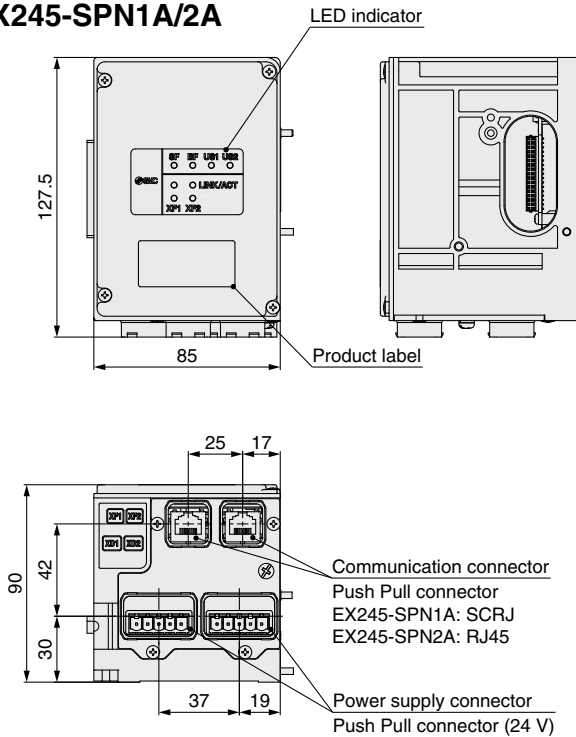

#### EX245-SPN3A

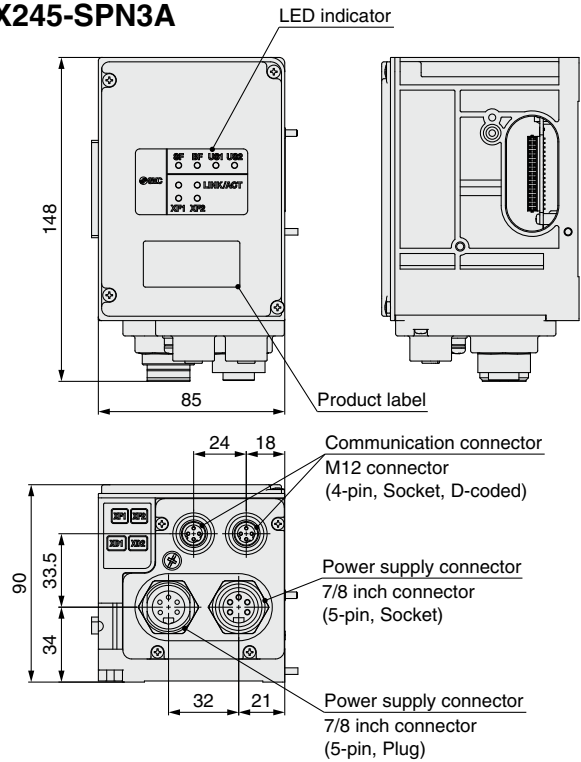

#### EX245-FPS1/2

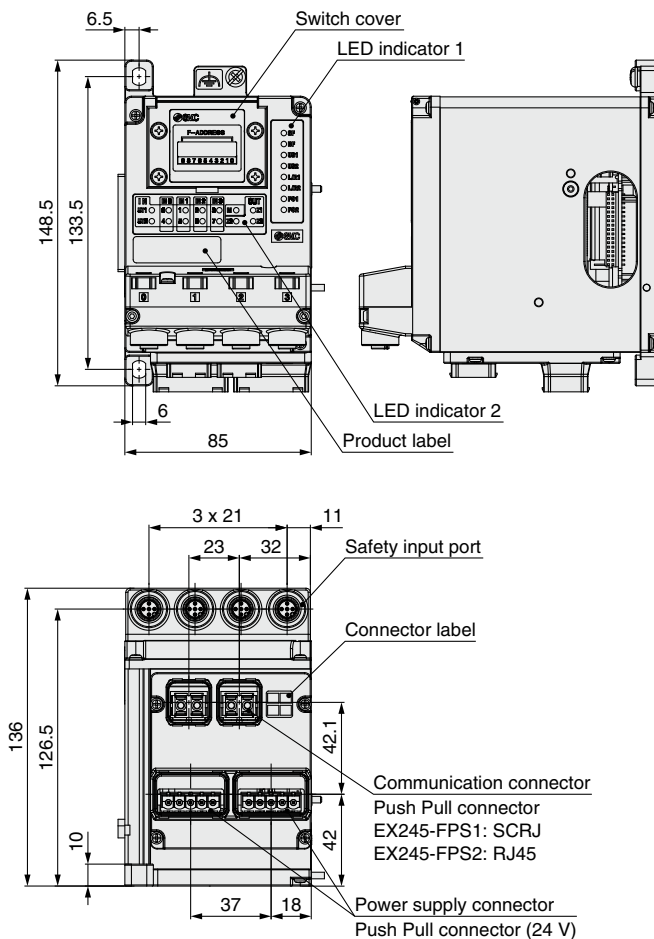

#### EX245-FPS3

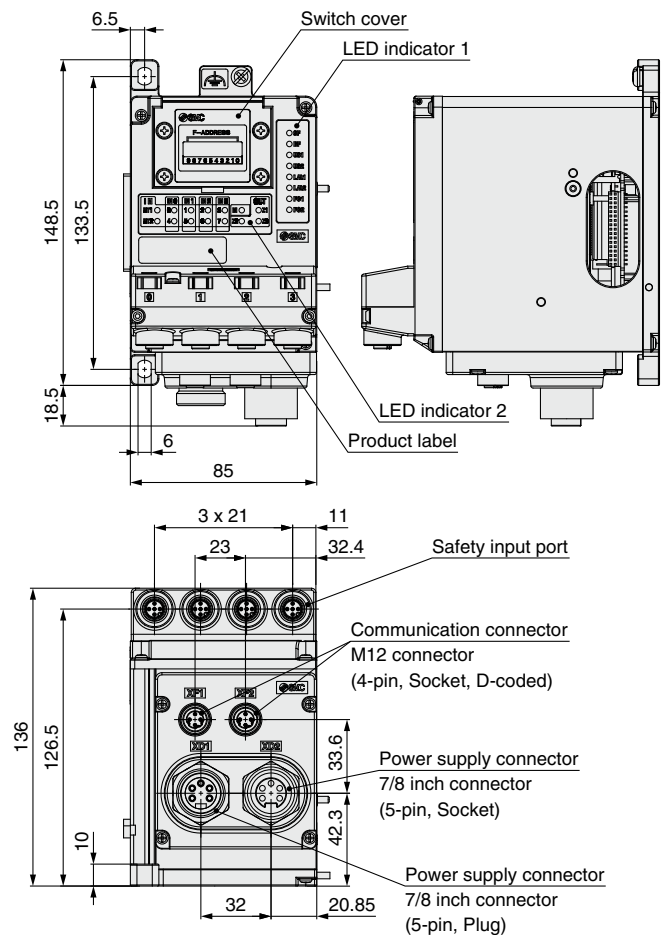

**Dimensions/Parts Description**

**Digital Input Module**

**EX245-DX1**

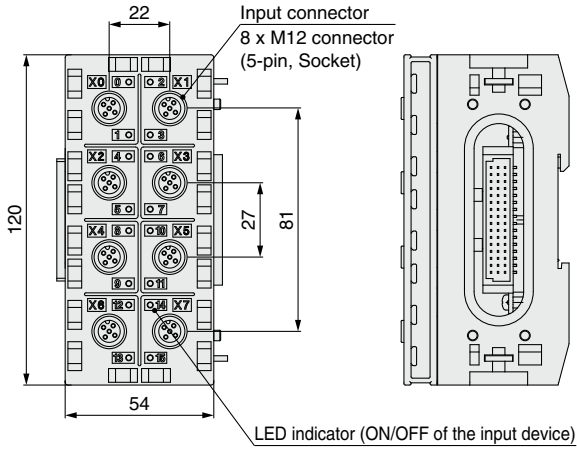

**Digital Output Module**

**EX245-DY1**

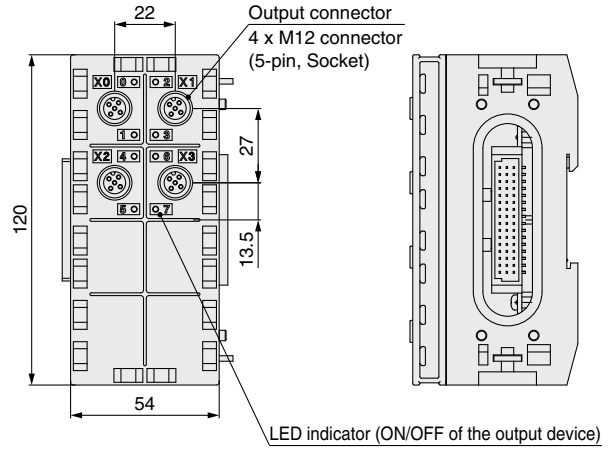

**IO-Link Module**

**EX245-LA1/LB1**

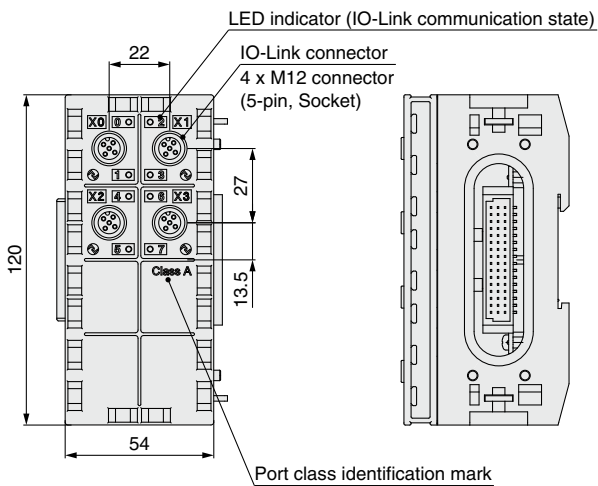

# EX245 Series

## Dimensions/Parts Description

### End Plate

**EX245-EA2-1 (General-purpose bracket)**

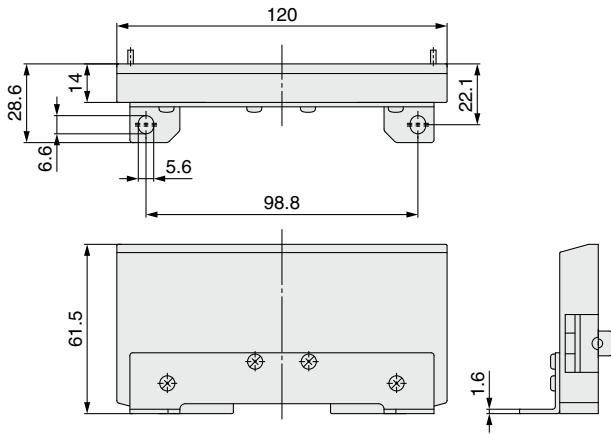

**EX245-EA2-2 (Without bracket)**

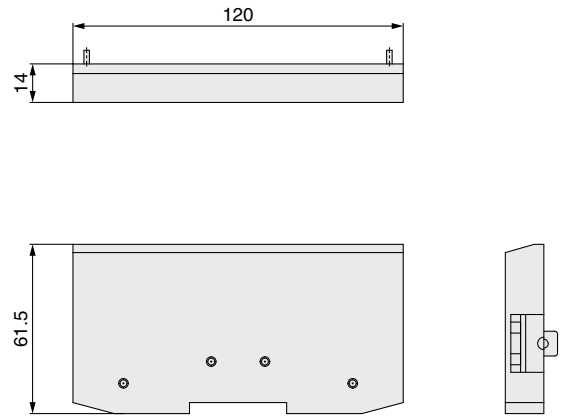

**EX245-EA2-3 (For JSY/SY)**

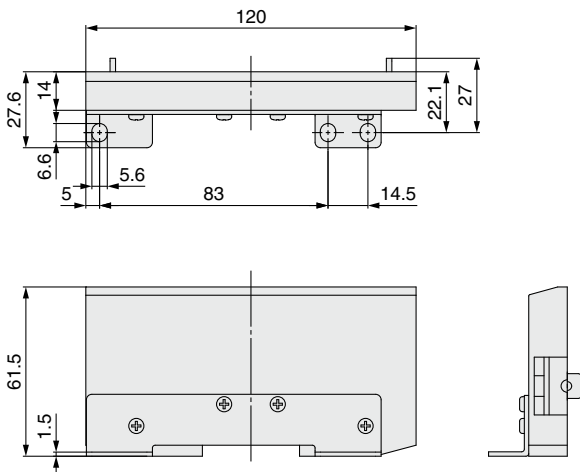

**EX245-EA2-4 (For VQC4000)**

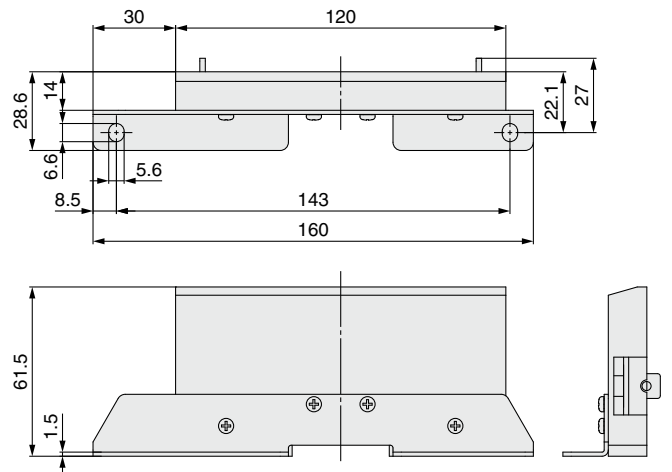

**EX245-EA2-5 (For VQC2000)**

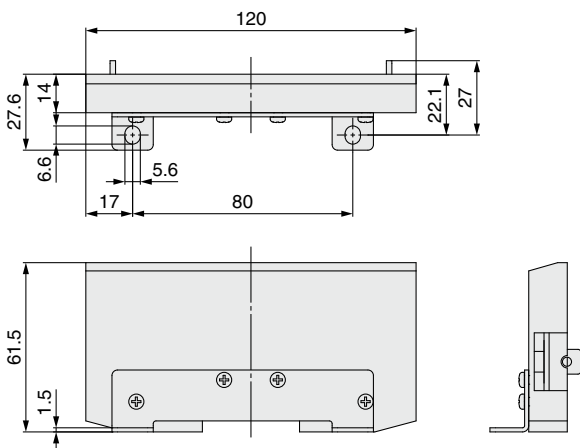



## Assembly Examples

Valve manifold	
SI unit	EX245-SPN1A
IO-Link module	EX245-L□1
Digital input module	EX245-DX1
Digital output module	EX245-DY1
End plate	EX245-EA2-3

\* If you are considering using a valve manifold compatible with PROFI-safe, be sure to check with your SMC sales representative prior to ordering.

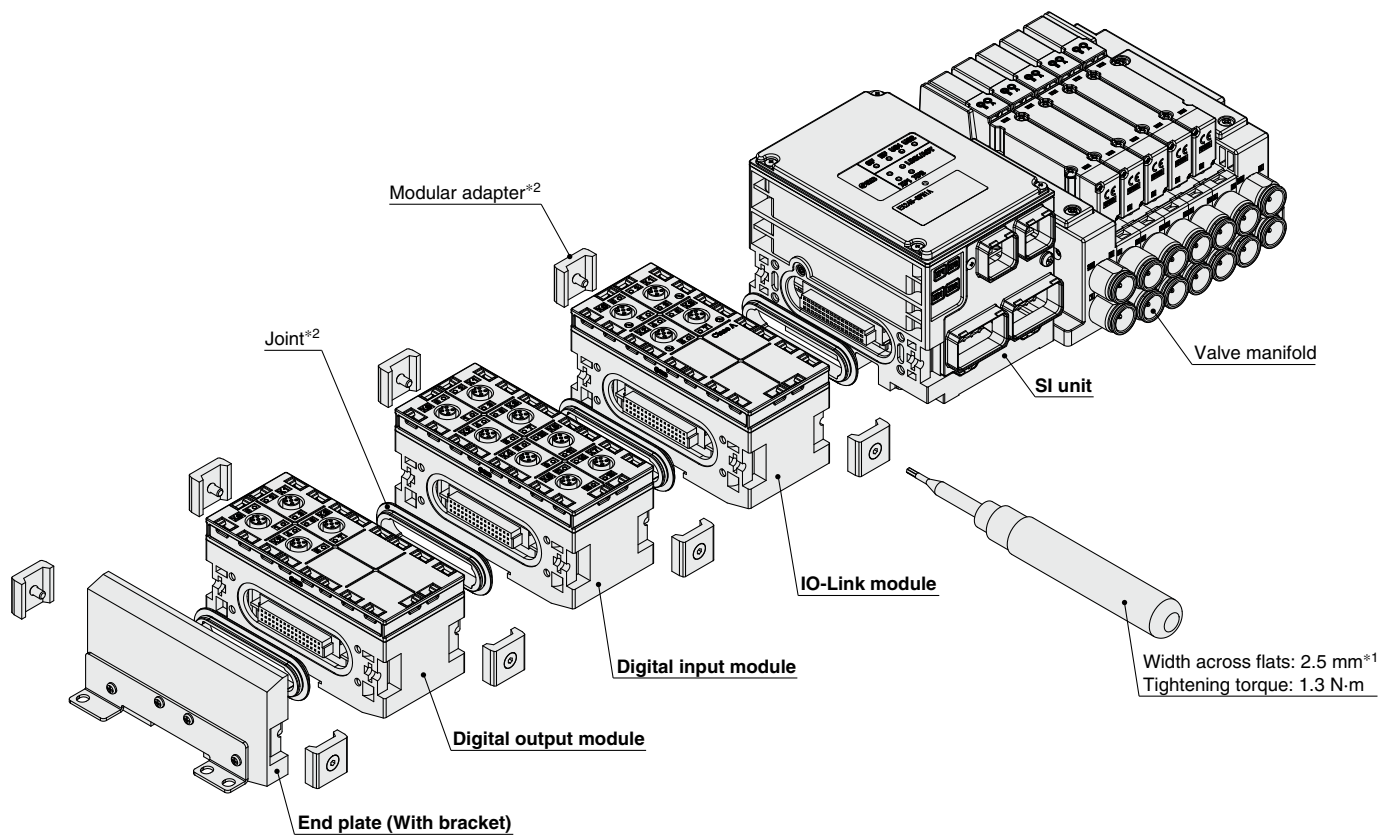
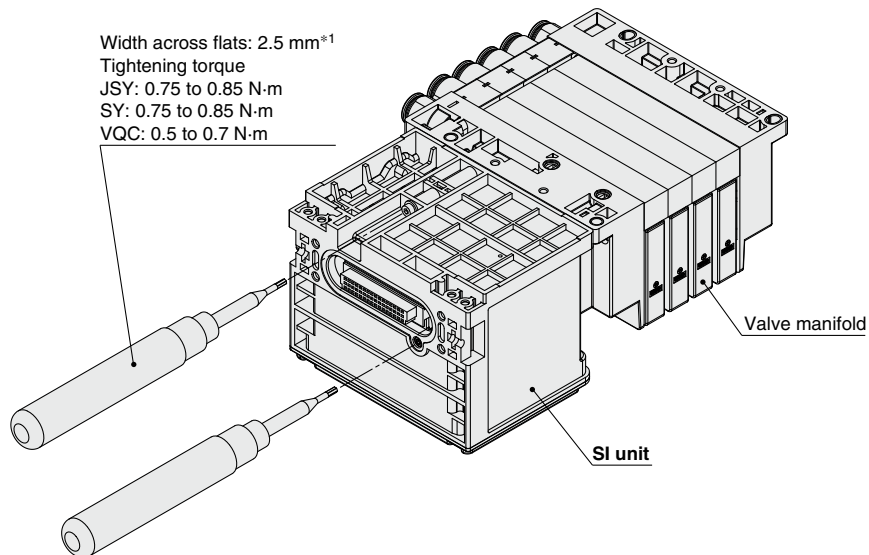

\*1 A tightening tool is not included. It should be provided by the customer.

\*2 The joint and modular adapter are shipped together with the digital input/output modules, IO-Link module, and end plate.

# EX245 Series Accessories

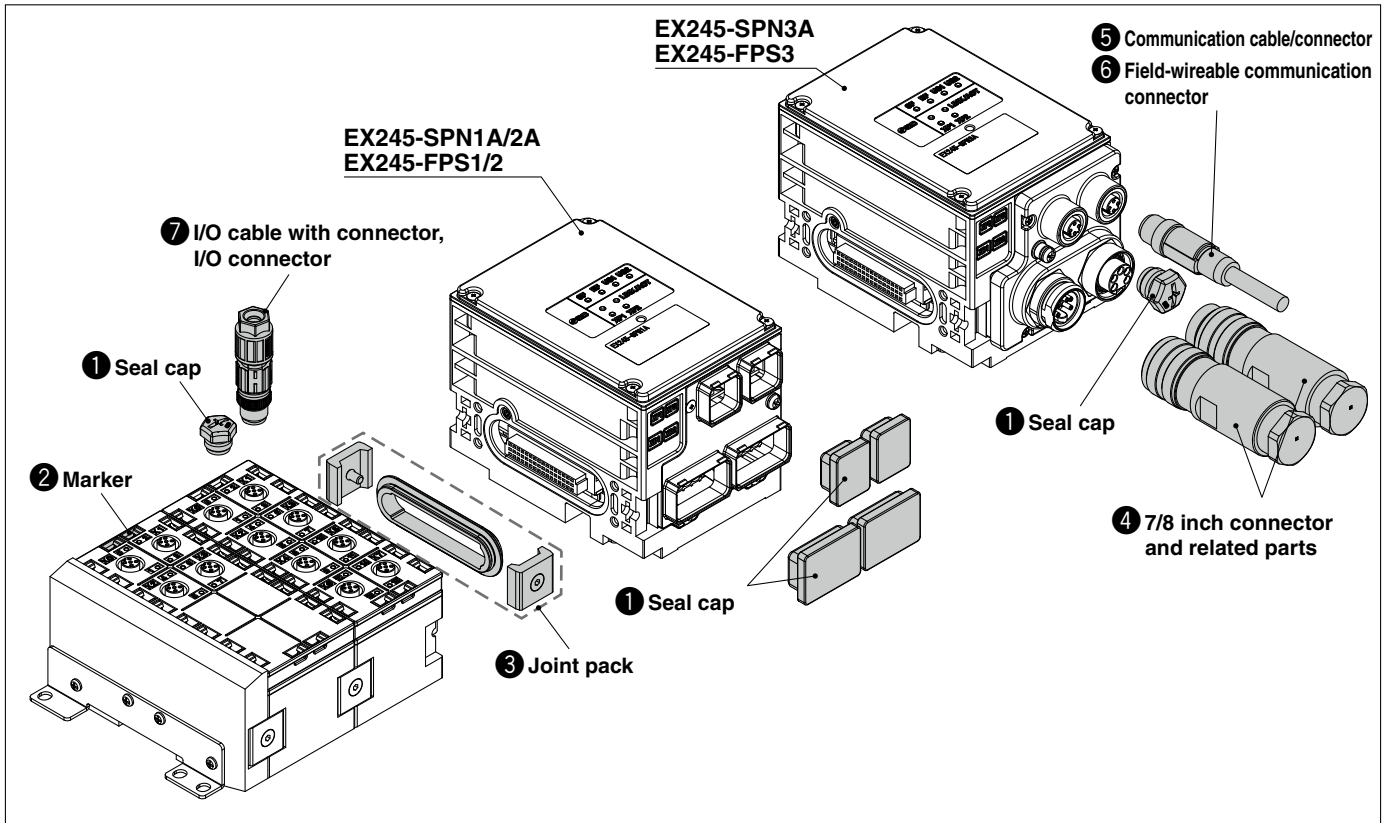

## ① Seal Cap (10 pcs.)

Be sure to mount a seal cap on any unused I/O connectors. Otherwise, the specified enclosure cannot be maintained.

**EX9-AWTS**  
For M12 (10 pcs.)



**Number of included seal caps**

Product number	EX9-AWTS
EX245-SPN1A/2A	—
EX245-SPN3A	1
EX245-FPS1/2	4
EX245-FPS3	6

**EX245-AWC**  
For communication connectors (10 pcs.)



**EX245-AWP**  
For power supply connectors (10 pcs.)



Seal cap for communication connector and power supply connector are included when EX245-SPN1A/2A or EX245-FPS1/2 is shipped (2 caps for each unit).

## ③ Joint Pack

EX245-ZJP

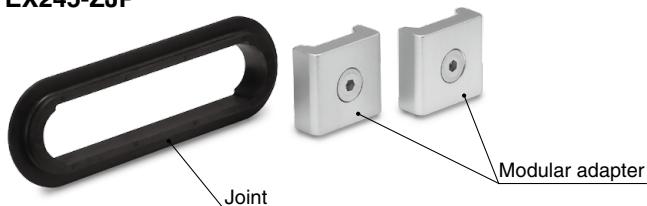

Included when EX245-DX1/DY1, EX245-EA2-□ are shipped.

## ② Marker (1 sheet, 88 pcs.)

The signal name of I/O device and each module name can be entered and mounted on each module.

EX600-ZT1

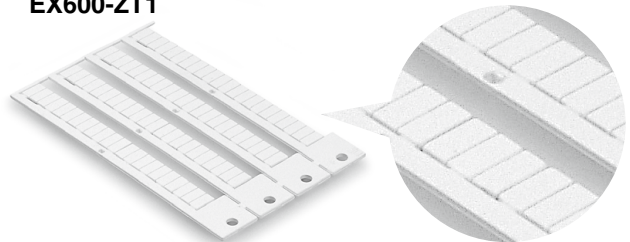

## ④ 7/8 Inch Connector and Related Parts

• Power supply cable (7/8 inch connector)

PCA-1558810 Straight 2 m

PCA-1558823 Straight 6 m



• Power supply field-wireable connector (7/8 inch)  
[Compatible with AWG22-16]

PCA-1578078 Plug

PCA-1578081 Socket



⑤ Communication Cable/Connector

**EX9-AC 005 EN-PSPS** (With connector on both sides (Plug/Plug))

● Cable length (L)

<b>005</b>	500 mm
<b>010</b>	1000 mm
<b>020</b>	2000 mm
<b>030</b>	3000 mm
<b>050</b>	5000 mm
<b>100</b>	10000 mm

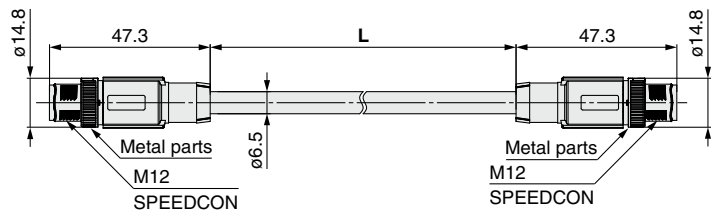

Item	Specifications
Cable O.D.	ø6.5 mm
Conductor nominal cross section	0.34 mm <sup>2</sup> /AWG22
Wire O.D. (Including insulator)	1.55 mm
Min. bending radius (Fixed)	19.5 mm

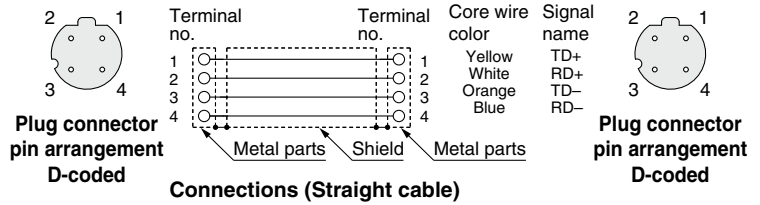

**EX9-AC 005 EN-PAPA** (With angled connector on both sides (Plug/Plug))

● Cable length (L)

<b>005</b>	500 mm
<b>010</b>	1000 mm
<b>020</b>	2000 mm
<b>030</b>	3000 mm
<b>050</b>	5000 mm
<b>100</b>	10000 mm

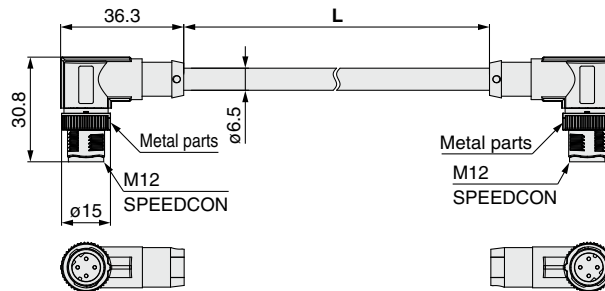

Item	Specifications
Cable O.D.	ø6.5 mm
Conductor nominal cross section	0.34 mm <sup>2</sup> /AWG22
Wire O.D. (Including insulator)	1.55 mm
Min. bending radius (Fixed)	19.5 mm

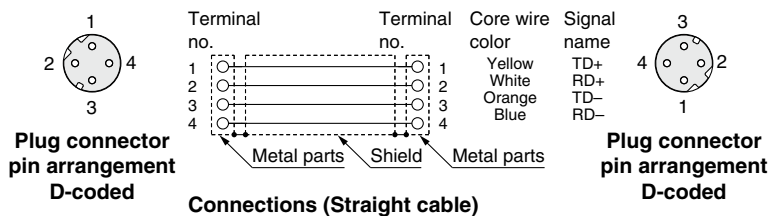

**PCA-1446566** (Plug)

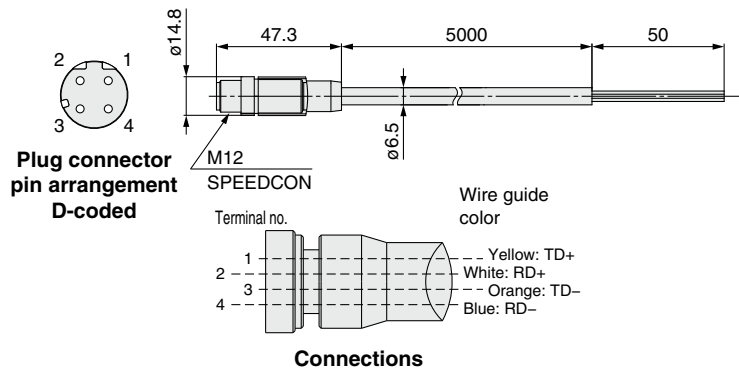

Item	Specifications
Cable O.D.	ø6.5 mm
Conductor nominal cross section	AWG22
Wire O.D. (Including insulator)	1.55 mm
Min. bending radius (Fixed)	45.5 mm

# EX245 Series

## ⑤ Communication Cable/Connector

### EX9-AC 020 EN-PSRJ (Plug/RJ-45 connector)

● Cable length (L)

010	1000 mm
020	2000 mm
030	3000 mm
050	5000 mm
100	10000 mm

Item	Specifications
Cable O.D.	ø6.4 mm
Conductor nominal cross section	0.14 mm <sup>2</sup> /AWG26
Wire O.D. (Including insulator)	0.98 mm
Min. bending radius (Fixed)	26 mm

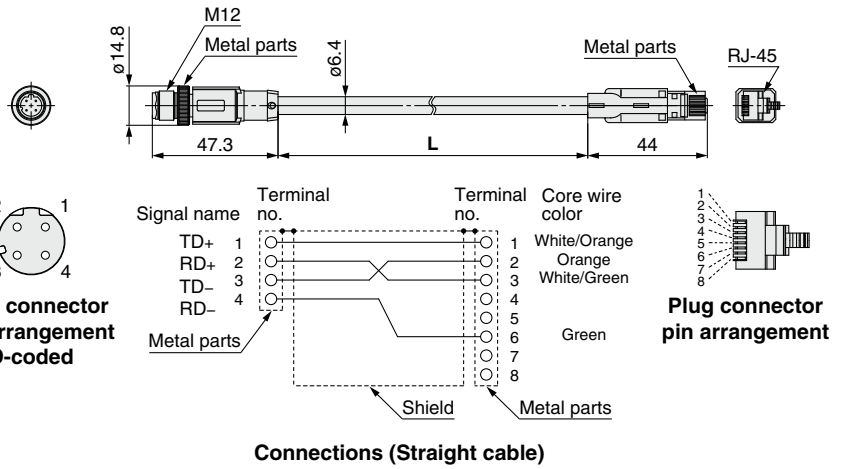

## ⑥ Field-wireable Communication Connector

### PCA-1446553

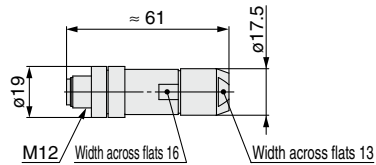
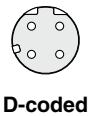



#### Applicable Cable

Item	Specifications
Cable O.D.	4.0 to 8.0 mm
Wire gauge (Stranded wire cross section)	0.14 to 0.34 mm <sup>2</sup> /AWG26 to 22

\* The table above shows the specifications for the applicable cable. Adaptation for the connector may vary on account of the conductor construction of the electric wire.



**7 I/O Cable with Connector, I/O Connector**

Name	Use	Part no.	Description
<b>Cable with connector</b>	For sensor 	<b>PCA-1557769</b>	Cable with M12 connector (4 pins/3 m)
		<b>PCA-1557772</b>	Cable with M8 connector (3 pins/3 m)
<b>Field-wireable connector</b>	For sensor 	<b>PCA-1557730</b>	Field-wireable connector (M8/3 pins/Plug/Piercecon® connection)
		<b>PCA-1557743</b>	Field-wireable connector (M12/4 pins/Plug/QUICKON-ONE connection/SPEEDCON)
		<b>PCA-1557756</b>	
<b>Y connector</b>	For sensor 	<b>PCA-1557785</b>	Y connector (2 x M12 (5 pins)-M12 (5 pins)/SPEEDCON)
		<b>PCA-1557798</b>	Y connector (2 x M8 (3 pins)-M12 (4 pins)/SPEEDCON)

\* When using the Y connector, connect it to the connector on the I/O module through the sensor cable with the M12 connector (PCA-1557769).

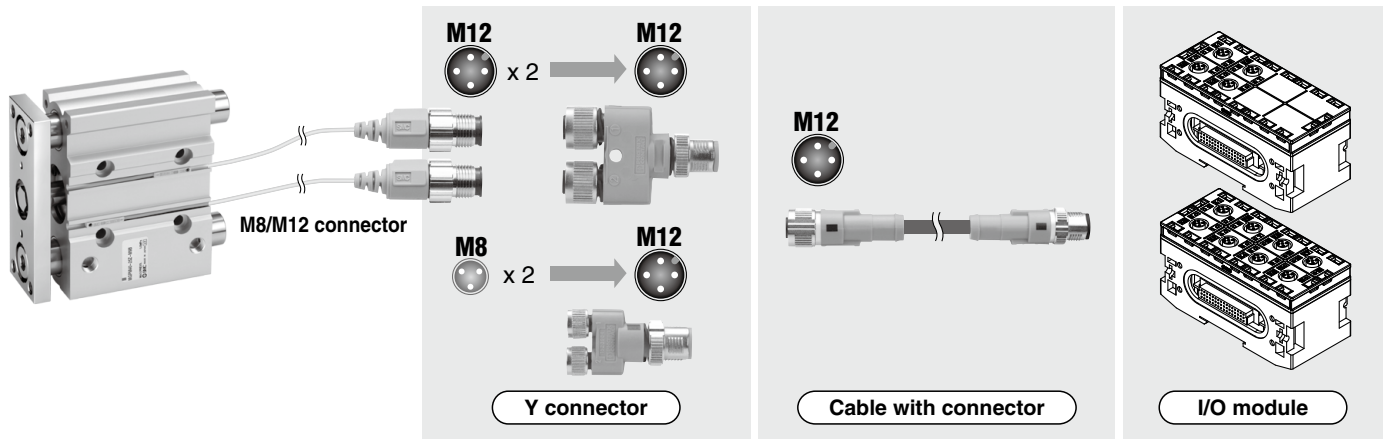

**For IO-Link Module**

**EX9-AC 005 -SSPS (With connector on both sides (Socket/Plug))**

**Cable length (L)**

<b>005</b>	500 mm
<b>010</b>	1000 mm
<b>020</b>	2000 mm
<b>030</b>	3000 mm
<b>050</b>	5000 mm
<b>100</b>	10000 mm

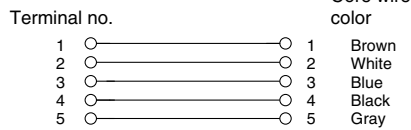
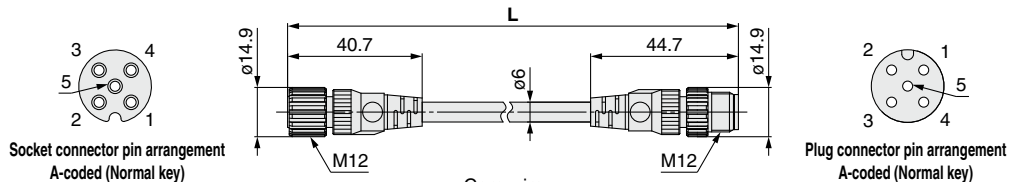

**Connections**

Item	Specifications
<b>Cable O.D.</b>	ø6 mm
<b>Conductor nominal cross section</b>	0.3 mm <sup>2</sup> /AWG22
<b>Wire O.D. (Including conductor)</b>	1.5 mm
<b>Min. bending radius (Fixed)</b>	40 mm

**EX9-AC 005 -SAPA (With connector on both sides (Socket/Plug))**

**Cable length (L)**

<b>005</b>	500 mm
<b>010</b>	1000 mm
<b>020</b>	2000 mm
<b>030</b>	3000 mm
<b>050</b>	5000 mm
<b>100</b>	10000 mm

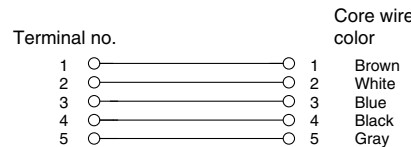
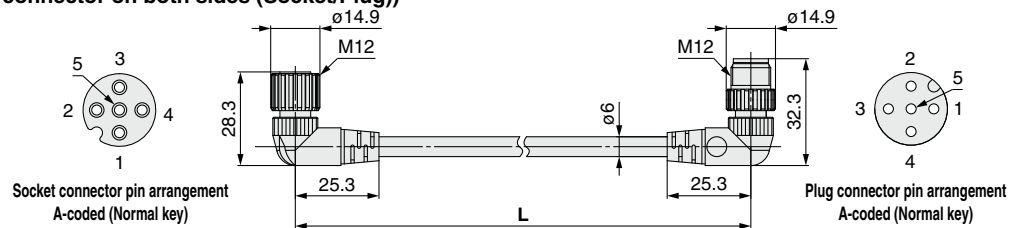

**Connections**

Item	Specifications
<b>Cable O.D.</b>	ø6 mm
<b>Conductor nominal cross section</b>	0.3 mm <sup>2</sup> /AWG22
<b>Wire O.D. (Including conductor)</b>	1.5 mm
<b>Min. bending radius (Fixed)</b>	40 mm

# EX245 Series

## ⑦ I/O Cable with Connector, I/O Connector

### Connection Example

**Port class A**

IO-Link module  
**EX245-LA1**

Power supply load

Y Branch Connector

IO-Link

**Port class A** compliant

A special wiring Y branch connector is available.

Used when connecting to a port class A type IO-Link module, which is often used when connecting to an IO-Link sensor

### Y Branch Connector for IO-Link

This connector is used to supply power to the valve manifold by branching the IO-Link communication cable in cases where a port class A IO-Link module is used.

#### EX9-ACY02-S

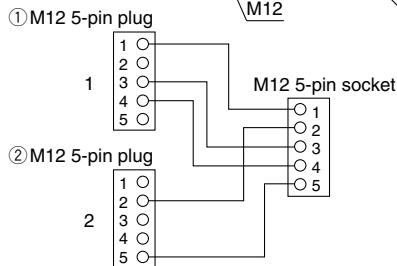
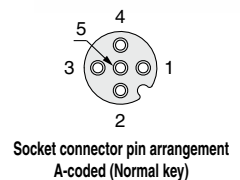
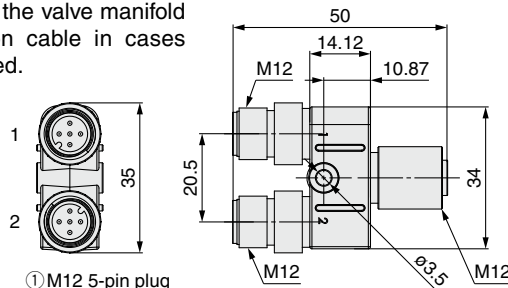
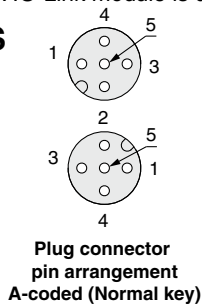

#### Solenoid valve power supply cable side pin arrangement when using a branch connector

1	—	Unused
2	SV24V	+24 V for solenoid valve
3	—	Unused
4	—	Unused
5	SV0V	0 V for solenoid valve

## ⑧ IO-Link Device Tool License Key

### USB dongle EX9-ZSW-LDT1

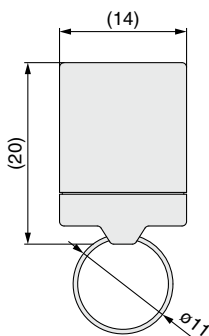
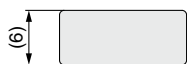





## EX245 Series

# Specific Product Precautions

Be sure to read this before handling the products. Refer to the back cover for safety instructions. For fieldbus system precautions, refer to the “Operation Manual” on the SMC website: <https://www.smcworld.com>

### Operating Environment

#### **Caution**

**1. Select the proper type of enclosure according to the operating environment.**

IP65 is achieved when the following conditions are met.

- 1) Provide appropriate wiring of the electrical wiring cables, communication connectors, and cables with M12 connectors.
- 2) Appropriately mount the SI unit, each module, and the manifold valve.
- 3) Be sure to mount a seal cap on any unused connectors.

If using in an environment that is exposed to water splashes, please take measures such as using a cover.



## Safety Instructions

These safety instructions are intended to prevent hazardous situations and/or equipment damage. These instructions indicate the level of potential hazard with the labels of “**Caution**,” “**Warning**” or “**Danger**.” They are all important notes for safety and must be followed in addition to International Standards (ISO/IEC)\*1), and other safety regulations.

 **Caution:** **Caution** indicates a hazard with a low level of risk which, if not avoided, could result in minor or moderate injury.

 **Warning:** **Warning** indicates a hazard with a medium level of risk which, if not avoided, could result in death or serious injury.

 **Danger:** **Danger** indicates a hazard with a high level of risk which, if not avoided, will result in death or serious injury.

\*1) ISO 4414: Pneumatic fluid power – General rules relating to systems.  
ISO 4413: Hydraulic fluid power – General rules relating to systems.  
IEC 60204-1: Safety of machinery – Electrical equipment of machines.  
(Part 1: General requirements)  
ISO 10218-1: Manipulating industrial robots – Safety.  
etc.

### Warning

#### 1. The compatibility of the product is the responsibility of the person who designs the equipment or decides its specifications.

Since the product specified here is used under various operating conditions, its compatibility with specific equipment must be decided by the person who designs the equipment or decides its specifications based on necessary analysis and test results. The expected performance and safety assurance of the equipment will be the responsibility of the person who has determined its compatibility with the product. This person should also continuously review all specifications of the product referring to its latest catalog information, with a view to giving due consideration to any possibility of equipment failure when configuring the equipment.

#### 2. Only personnel with appropriate training should operate machinery and equipment.

The product specified here may become unsafe if handled incorrectly. The assembly, operation and maintenance of machines or equipment including our products must be performed by an operator who is appropriately trained and experienced.

#### 3. Do not service or attempt to remove product and machinery/equipment until safety is confirmed.

1. The inspection and maintenance of machinery/equipment should only be performed after measures to prevent falling or runaway of the driven objects have been confirmed.
2. When the product is to be removed, confirm that the safety measures as mentioned above are implemented and the power from any appropriate source is cut, and read and understand the specific product precautions of all relevant products carefully.
3. Before machinery/equipment is restarted, take measures to prevent unexpected operation and malfunction.

#### 4. Contact SMC beforehand and take special consideration of safety measures if the product is to be used in any of the following conditions.

1. Conditions and environments outside of the given specifications, or use outdoors or in a place exposed to direct sunlight.
2. Installation on equipment in conjunction with atomic energy, railways, air navigation, space, shipping, vehicles, military, medical treatment, combustion and recreation, or equipment in contact with food and beverages, emergency stop circuits, clutch and brake circuits in press applications, safety equipment or other applications unsuitable for the standard specifications described in the product catalog.
3. An application which could have negative effects on people, property, or animals requiring special safety analysis.
4. Use in an interlock circuit, which requires the provision of double interlock for possible failure by using a mechanical protective function, and periodical checks to confirm proper operation.

### Caution

#### 1. The product is provided for use in manufacturing industries.

The product herein described is basically provided for peaceful use in manufacturing industries.  
If considering using the product in other industries, consult SMC beforehand and exchange specifications or a contract if necessary.  
If anything is unclear, contact your nearest sales branch.

### Limited warranty and Disclaimer/ Compliance Requirements

The product used is subject to the following “Limited warranty and Disclaimer” and “Compliance Requirements”.

Read and accept them before using the product.

#### Limited warranty and Disclaimer

1. The warranty period of the product is 1 year in service or 1.5 years after the product is delivered, whichever is first.\*2)  
Also, the product may have specified durability, running distance or replacement parts. Please consult your nearest sales branch.
2. For any failure or damage reported within the warranty period which is clearly our responsibility, a replacement product or necessary parts will be provided.  
This limited warranty applies only to our product independently, and not to any other damage incurred due to the failure of the product.
3. Prior to using SMC products, please read and understand the warranty terms and disclaimers noted in the specified catalog for the particular products.

##### \*2) Vacuum pads are excluded from this 1 year warranty.

A vacuum pad is a consumable part, so it is warranted for a year after it is delivered.  
Also, even within the warranty period, the wear of a product due to the use of the vacuum pad or failure due to the deterioration of rubber material are not covered by the limited warranty.

#### Compliance Requirements

1. The use of SMC products with production equipment for the manufacture of weapons of mass destruction (WMD) or any other weapon is strictly prohibited.
2. The exports of SMC products or technology from one country to another are governed by the relevant security laws and regulations of the countries involved in the transaction. Prior to the shipment of a SMC product to another country, assure that all local rules governing that export are known and followed.

### Caution

#### SMC products are not intended for use as instruments for legal metrology.

Measurement instruments that SMC manufactures or sells have not been qualified by type approval tests relevant to the metrology (measurement) laws of each country. Therefore, SMC products cannot be used for business or certification ordained by the metrology (measurement) laws of each country.

#### Revision History

**Edition B** \* A PROFIsafe compatible product has been added.  
\* Number of pages has been increased from 16 to 24.

ZR

 **Safety Instructions** Be sure to read the “Handling Precautions for SMC Products” (M-E03-3) and “Operation Manual” before use.

## SMC Corporation

Akihabara UDX 15F,  
4-14-1, Sotokanda, Chiyoda-ku, Tokyo 101-0021, JAPAN  
Phone: 03-5207-8249 Fax: 03-5298-5362  
<https://www.smcworld.com>  
© 2021 SMC Corporation All Rights Reserved

Specifications are subject to change without prior notice  
and any obligation on the part of the manufacturer.

D-G