

Compact 5-Port Solenoid Valve

JSY1000/3000/5000 Series

Non Plug-in

Size reduction possible thanks to a flow increase
This leads to space saving, weight reduction, and a large flow rate.



Possible to drive $\varnothing 32^{*1}$ bore cylinders

JSY1000

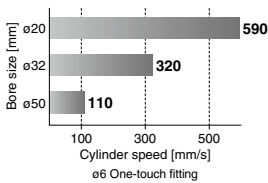
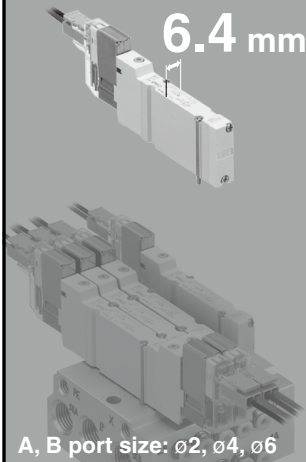

Possible to drive $\varnothing 50^{*1}$ bore cylinders

JSY3000

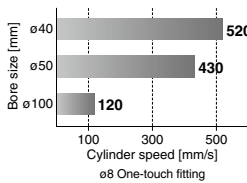
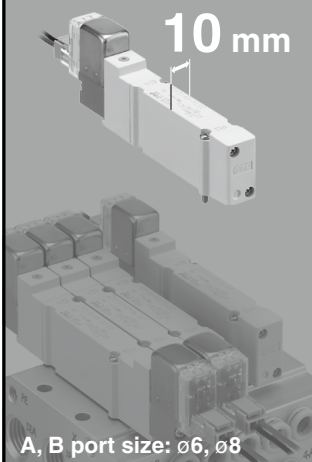

Possible to drive $\varnothing 80^{*1}$ bore cylinders

JSY5000

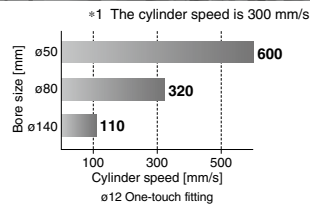
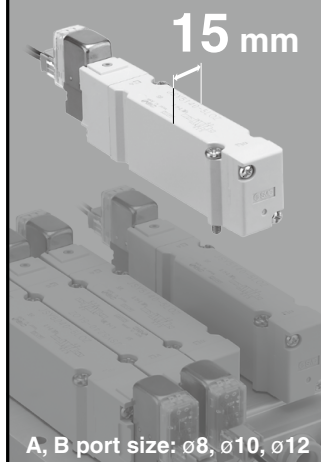

Refer to pages 168 to 171 for detailed conditions regarding the above cylinder speed.

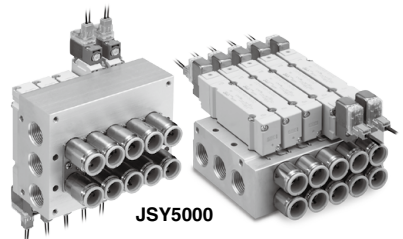
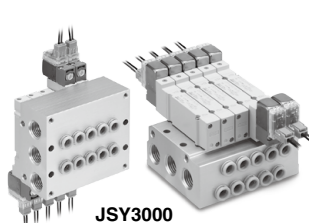
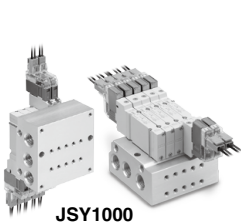

Series Map

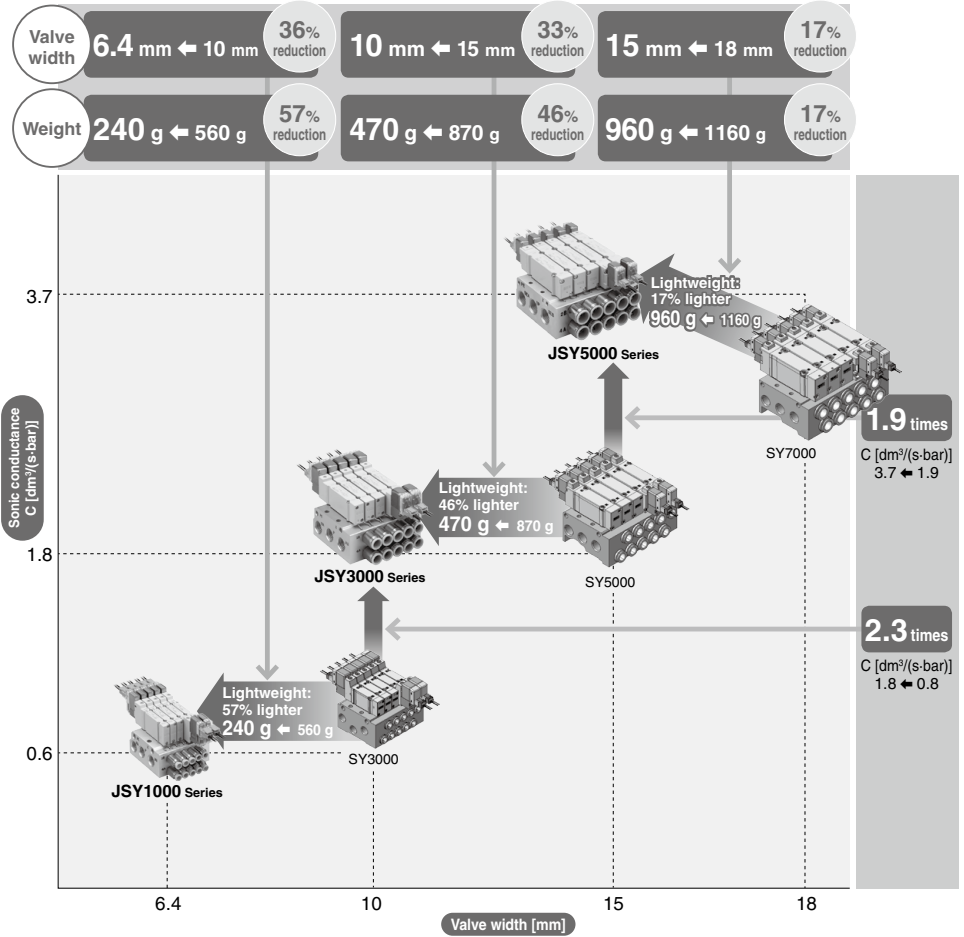

Power Consumption



Power consumption is reduced by power saving circuit.

Power consumption is decreased to approx. 1/2.5 to 1/4 of the amount consumed at startup by reducing the wattage required to hold the valve in an energized state. (Effective energizing time is over 62 ms at 24 VDC.) Refer to the electrical power waveform as shown on the right.

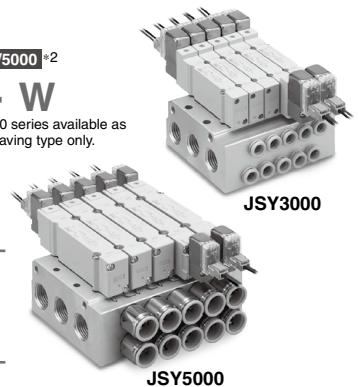
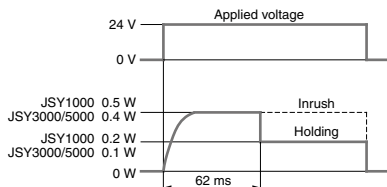

Space Saving

Volume
Max. **36% reduction**

Weight
Max. **57% reduction**

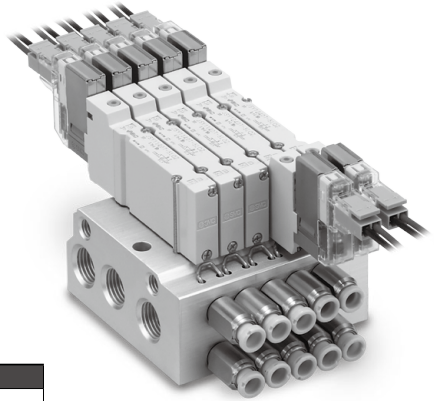

	Volume [cm ³]	Weight [g]
JSY1000	210	240
SY3000	330	560
JSY3000	460	470
SY5000	640	870
JSY5000	850	960
SY7000	990	1160

4-Position Dual 3-Port Valve Available

- Two 3-port valves built into one body

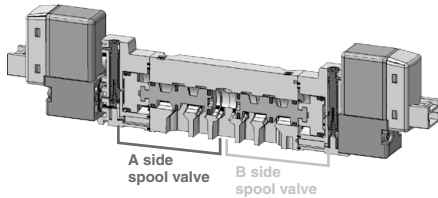

- 3-port valves on the A and B sides can operate independently.
- When used as a 3-port valve, only half the number of stations is required.
- Can also be used as a 4-position, 5-port valve

• Combination examples

Model	A side	B side
JSY□A4□	N.C. valve	N.C. valve
JSY□B4□	N.O. valve	N.O. valve
JSY□C4□	N.C. valve	N.O. valve

Bottom ported is prepared (A, B port).

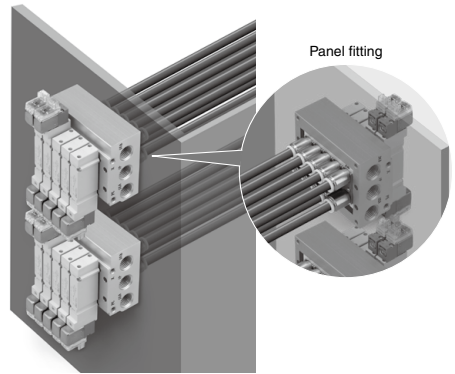

Application Examples

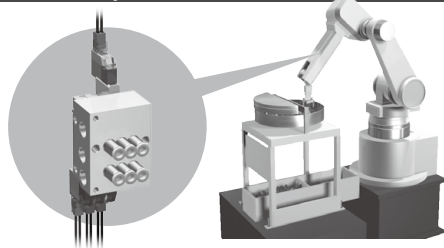
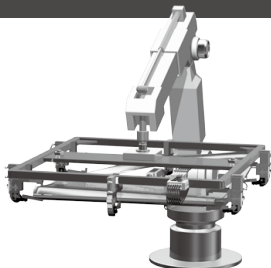

Series Variations

	Piping direction 4 (A), 2 (B) port	Sonic conduction C [dm ² /(s·bar)] 4/2→5/3 (A/B→EA/EB)	Type of actuation	Rated voltage	Port size								Manifold Options				Valve Options				
					A, B port								P, E port	Blanking plate	Individual SUP spacer	Individual EXH spacer	Vacuum/Low pressure specification	Different pressures	Reverse pressure	Mixed fitting sizes	Enclosure IP65 compliant
					Thread piping				One-touch fitting												
					M3	M5	1/8	1/4	ø2	ø4	ø6	ø8									
JSY 1000	Side	0.63	2-position single (A)4 (B)2 (EA)5 1 3(EB) (P)	24 VDC																	
	Bottom				2-position double (A)4 (B)2 (EA)5 1 3(EB) (P)	●	●	—	—	●	●	—	—	—	—	1/8					
JSY 3000	Side	1.81	3-position exhaust center (A)4 (B)2 (EA)5 1 3(EB) (P)	24 VDC																	
	Bottom				3-position pressure center (A)4 (B)2 (EA)5 1 3(EB) (P)	●	●	—	—	●	●	—	—	—	1/4	○ p.201	○ p.201	○ p.201	▲ External pilot	○ Individual SUP	▲ External pilot
JSY 5000	Side	3.72	4-position dual 3-port valve 4(A) 2(B) 5(EA) 1(P) 3(EB)	24 VDC																	
	Bottom				N.O. valve x 2 pcs. 4(A) 2(B) 5(EA) 1(P) 3(EB)	—	—	●	●	—	—	●	●	●	3/8						
		4.47	N.C. valve, N.O. valve 4(A) 2(B) 5(EA) 1(P) 3(EB)																●*1		

● Standard ○ Option ▲ Made to Order (Refer to page 203.)

*1 When using M8 connector.

Manifold Options

Individual SUP spacer p.201

When the same manifold is used for different pressures, an individual SUP spacer is used as a supply port for different pressures.

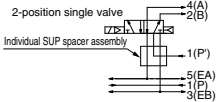
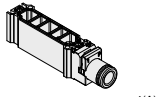

Circuit diagram

(Mounting example of a 2-position single valve)

Individual EXH spacer p.201

When valve exhaust affects other stations due to the circuit configuration, this spacer is used for individual valve exhaust.

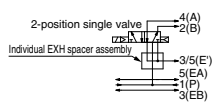
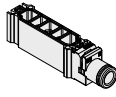

Circuit diagram

(Mounting example of a 2-position single valve)

Blanking plate p.201

Used when valve additions are expected or for maintenance.

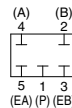

Tube Releasing Tool

This tool is used for removing the tube from port A and B. p.199

For JSY1000 For JSY1000/3000

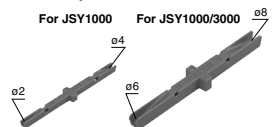

For JSY5000



CONTENTS

Optimum Actuation Size Chart of Air Cylinder.....	p. 168	Valve Construction	p. 174
Valve Specifications (Specifications, Response Time, Weight).....	p. 172	Valve Replacement Parts	p. 175

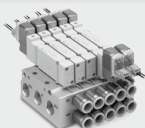







Manifold

Non Plug-in

Metal Base

Type 40 Side Ported/Type 41 Bottom Ported

p. 177

		Non Plug-in Metal Base (Specifications, Flow Rate Characteristics, Weight).....	p. 177
JSY1000 Side ported	JSY1000 Bottom ported	Dimensions/JSY1000: Type 40 Side Ported	p. 180
		Dimensions/JSY1000: Type 41 Bottom Ported	p. 183
JSY3000 Side ported	JSY3000 Bottom ported	Dimensions/JSY3000: Type 40 Side Ported	p. 186
		Dimensions/JSY3000: Type 41 Bottom Ported	p. 189
JSY5000 Side ported	JSY5000 Bottom ported	Dimensions/JSY5000: Type 40 Side Ported	p. 192
		Dimensions/JSY5000: Type 41 Bottom Ported	p. 195

Manifold Exploded View	p. 198
One-touch Fittings, Clip, Port Plate, Tube Releasing Tool	p. 199
Manifold Options	p. 200
Made to Order	p. 203
Specific Product Precautions	p. 204

Optimum Actuation Size Chart of Air Cylinder

For JSY1000, A, B port: $\phi 4$

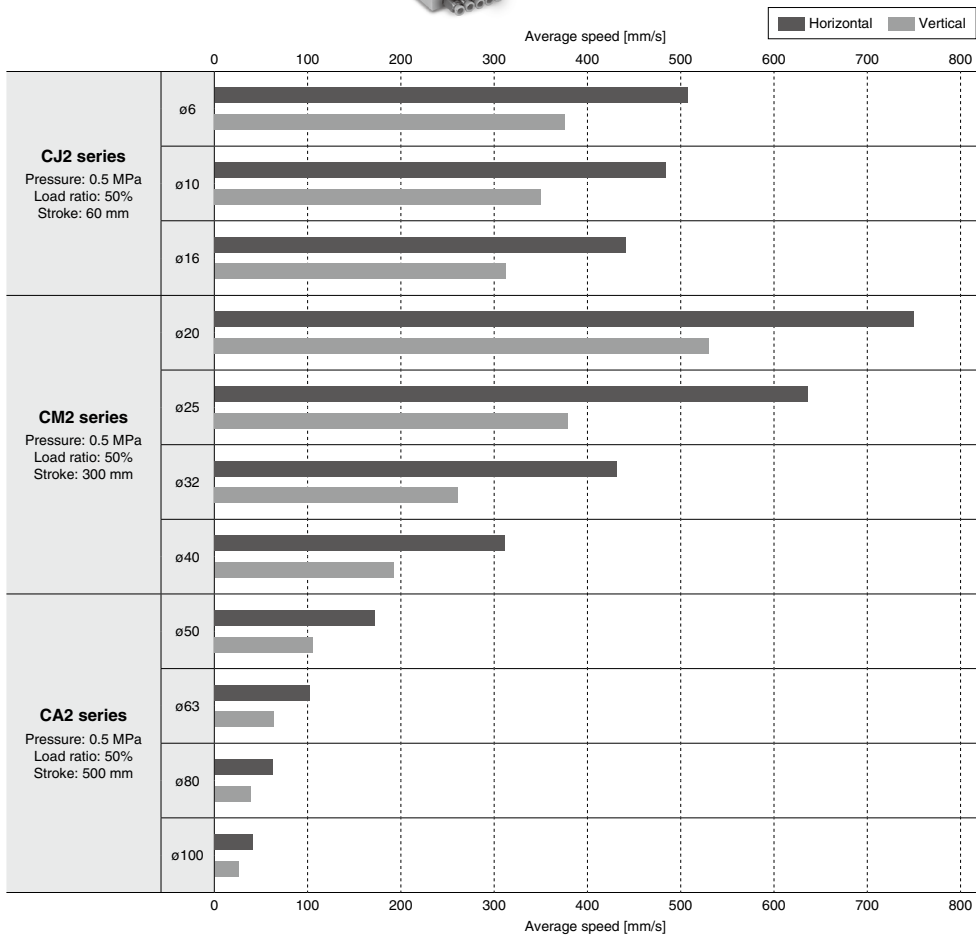
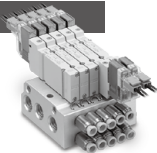

- * Values at extension of a directly coupled cylinder when meter-out speed controllers are used with the needle full open.
- * The average speed of the cylinder is obtained by dividing the stroke by the total stroke time.
- * Formula for load ratio: Load ratio = ((Load mass x 9.8)/Theoretical output) x 100%
- * Cylinder for horizontal use are based on the coefficient of rolling friction 0.1.
- * Operating piston speed is different depending on the applicable cylinder. Refer to the cylinder catalog for details.

Optimum Actuation Size Chart of Air Cylinder

For JSY1000, A, B port: $\phi 6$

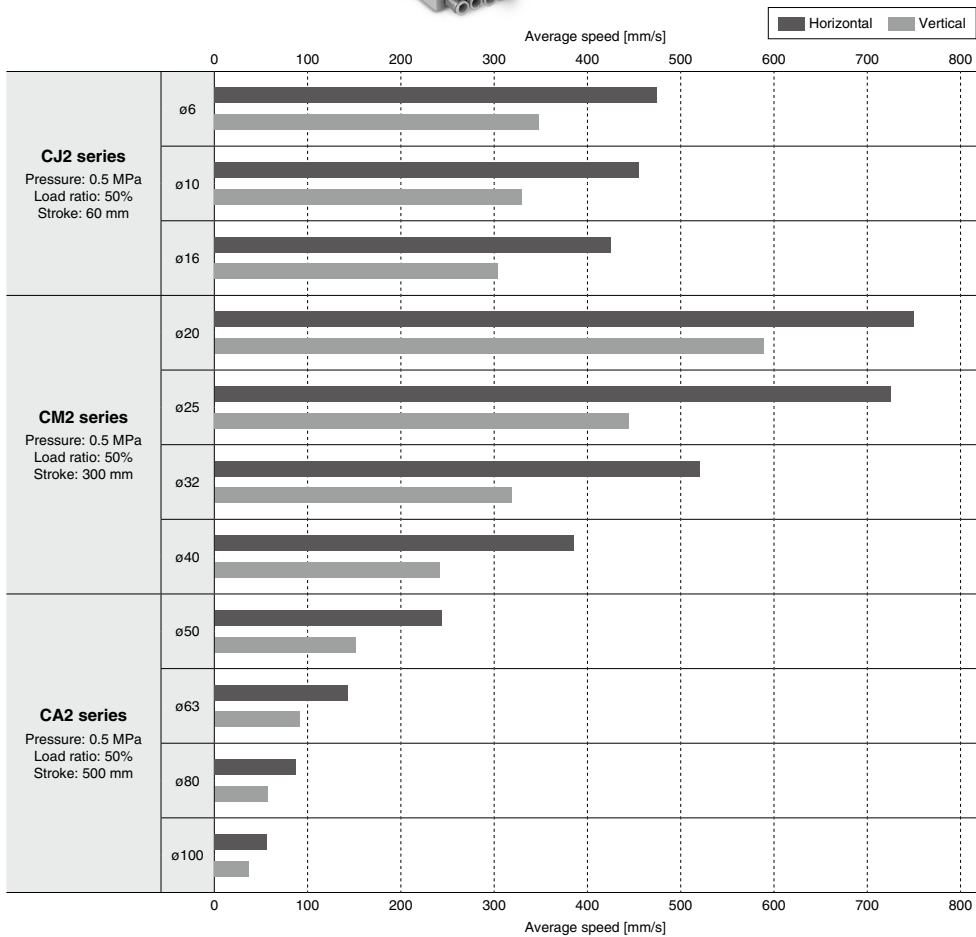
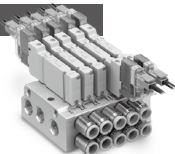

- * Values at extension of a directly coupled cylinder when meter-out speed controllers are used with the needle full open.
- * The average speed of the cylinder is obtained by dividing the stroke by the total stroke time.
- * Formula for load ratio: Load ratio = ((Load mass x 9.8)/Theoretical output) x 100%
- * Cylinder for horizontal use are based on the coefficient of rolling friction 0.1.
- * Operating piston speed is different depending on the applicable cylinder. Refer to the cylinder catalog for details.

Optimum Actuation Size Chart of Air Cylinder

For JSY3000, A, B port: $\phi 8$

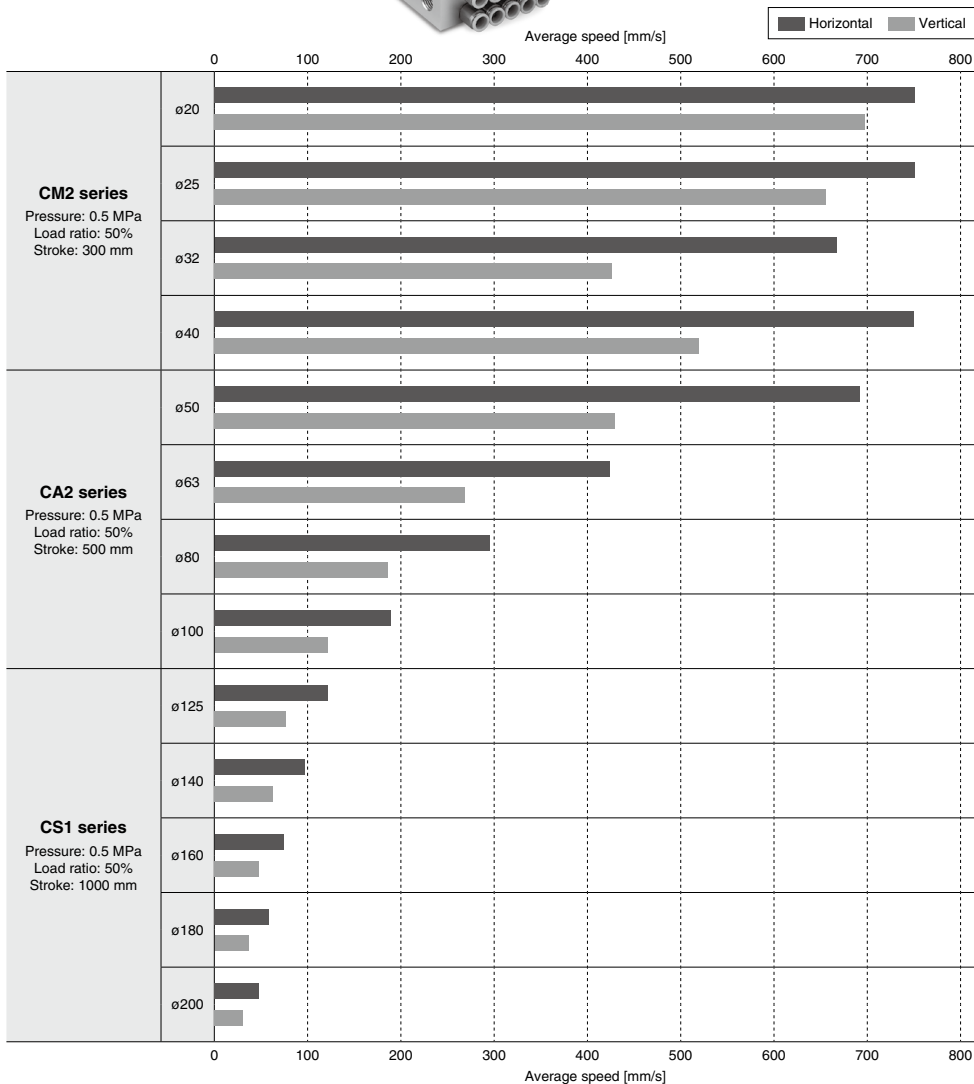
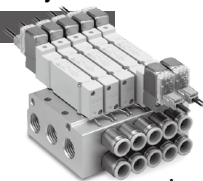

- * Values at extension of a directly coupled cylinder when meter-out speed controllers are used with the needle full open.
- * The average speed of the cylinder is obtained by dividing the stroke by the total stroke time.
- * Formula for load ratio: Load ratio = ((Load mass x 9.8)/Theoretical output) x 100%
- * Cylinder for horizontal use are based on the coefficient of rolling friction 0.1.
- * Operating piston speed is different depending on the applicable cylinder. Refer to the cylinder catalog for details.

Optimum Actuation Size Chart of Air Cylinder

For JSY5000, A, B port: $\phi 12$

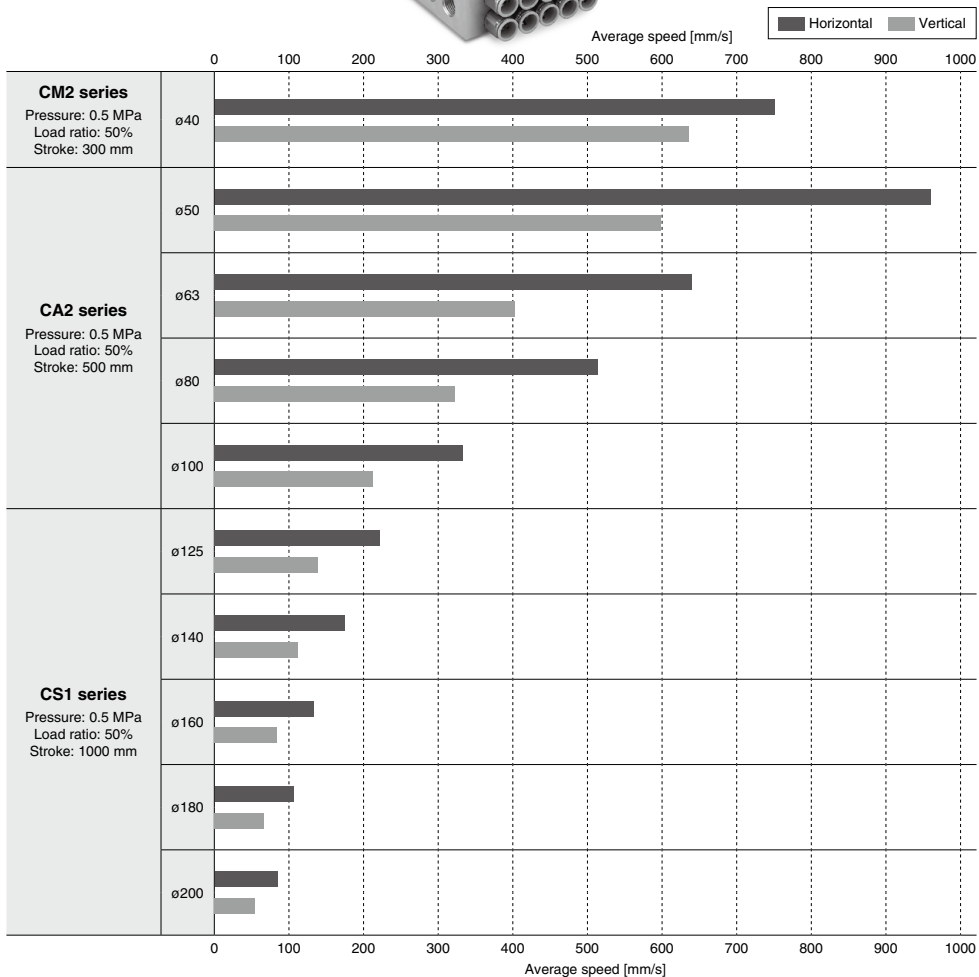
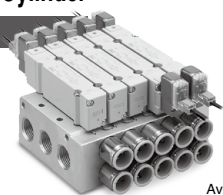

* Values at extension of a directly coupled cylinder when meter-out speed controllers are used with the needle full open.
 * The average speed of the cylinder is obtained by dividing the stroke by the total stroke time.
 * Formula for load ratio: Load ratio = ((Load mass x 9.8)/Theoretical output) x 100%
 * Cylinder for horizontal use are based on the coefficient of rolling friction 0.1.
 * Operating piston speed is different depending on the applicable cylinder. Refer to the cylinder catalog for details.

JSY1000/3000/5000 Series Valve Specifications

Valve Specifications

Valve type			Rubber seal
Fluid			Air
Internal pilot operating pressure range [MPa]	2-position single		0.15 to 0.7
	2-position double		0.1 to 0.7
	3-position		0.2 to 0.7
	4-position dual 3-port valve		0.15 to 0.7
External pilot operating pressure range [MPa] (Made to Order)	Operating pressure range		-100 kPa to 0.7
	Pilot pressure range	2-position single	0.25 to 0.7
		2-position double	
		3-position	
Ambient and fluid temperatures [°C]			-10 to 50 (No freezing)
Max. operating frequency [Hz]	JSY1000/3000	2-position single/double	5
		4-position dual 3-port valve	
		3-position	3
	JSY5000	2-position single/double	5
		4-position dual 3-port valve	3
	3-position	3	
Manual override			Non-locking push type
			Push-turn locking slotted type
			Push-turn locking lever type
Pilot exhaust type	Internal pilot		Individual exhaust
	External pilot (Made to Order)		
Lubrication			Not required
Mounting orientation ^{*1}			Unrestricted
Impact/Vibration resistance ^{*1} [m/s ²]			150/30
Enclosure			IP40/IP65: M8 connector (W) (WA) type
Electrical entry			L plug connector (L), M plug connector (M), M8 connector (W)(WA)
Coil rated voltage [V]			24 VDC
Allowable voltage fluctuation		JSY1000	-7% to +10% of the rated voltage (24 VDC)
		JSY3000/5000	±10% of the rated voltage
Power consumption [W]	DC	Standard	0.4
		With power ^{*3} saving circuit	JSY1000
	JSY3000/5000 (Made to Order)		0.1 ^{*4} [Inrush 0.4, Holding 0.1]
Surge voltage suppressor			Diode
Indicator light			LED

*1 Impact resistance: No malfunction occurred when it is tested in the axial direction and at the right angles to the main valve and armature in both energized and de-energized states every once for each condition. (Values at the initial period)

Vibration resistance: No malfunction occurred in a one-sweep test between 45 and 2000 Hz. Test was performed at both energized and de-energized states in the axial direction and at the right angles to the main valve and armature. (Values at the initial period)

Refer to page 209 for the fixation of DIN rail mounting type manifold.

*2 JSY1000 series available as power saving type only. Standard type (without power saving circuit) cannot be selected.

*3 M8 connector with power saving circuit are not available.

*4 For details, refer to page 207.

Valve Specifications *JSY1000/3000/5000 Series*

Response Time/Valve Weight

Series	Seal type	Model	Type of actuation	Response time [ms] (at 0.5 MPa)*1		Weight [g]	
				Standard	Z type	L/M plug connector	W/WA M8 connector
				With light/surge voltage suppressor			
JSY1000	Rubber seal	JSY1140T	2-position single	15		17	—
		JSY1240T	2-position double	5		24	
		JSY1(3/4/5)40T	3-position	13		25	
		JSY1(A/B/C)40T	4-position dual 3-port valve	14		24	
JSY3000		JSY3140	2-position single	27		34	38
		JSY3240	2-position double	10		49	57
		JSY3(3/4/5)40	3-position	30		52	60
		JSY3(A/B/C)40	4-position dual 3-port valve	27		48	56
JSY5000		JSY5140	2-position single	42		66	70
		JSY5240	2-position double	13		83	91
		JSY5(3/4/5)40	3-position	40		93	101
		JSY5(A/B/C)40	4-position dual 3-port valve	41		80	88

*1 Based on dynamic performance test, JIS B 8419-2010. (Coil temperature: 20°C, at rated voltage)

JSY1000/3000/5000 Series Valve Construction

Rubber Seal

2-position single

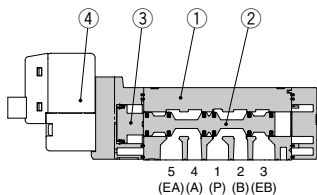

2-position single

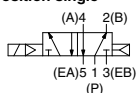

2-position double

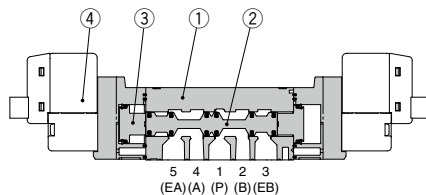

2-position double

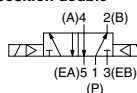

3-position closed center/exhaust center/pressure center

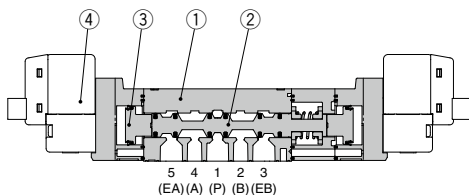

3-position closed center

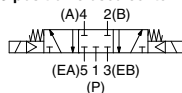

3-position exhaust center

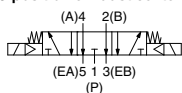

3-position pressure center

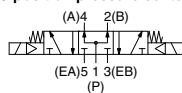

4-position dual 3-port valve

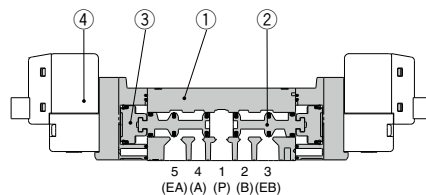

4-position dual 3-port valve

N.C. valve x 2 pcs.

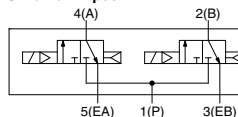

N.O. valve x 2 pcs.

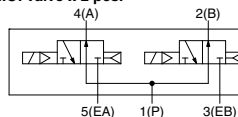

N.C. valve, N.O. valve 1 pc. of each

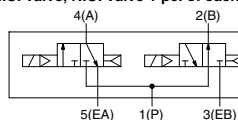

Component Parts

No.	Description	Material
1	Body	Aluminum die-casted
2	Spool valve	Aluminum/HNBR (4-position solenoid valve: Resin/HNBR)
3	Piston	Resin
4	Pilot valve assembly	—

JSY1000/3000/5000 Series Valve Replacement Parts

How to Order Pilot Valves

For JSY1000

V050 T - 5 □ Z

Coil type

T	With power saving circuit
---	---------------------------

Rated voltage

5	24 VDC
---	--------

Electrical entry

L	L plug connector	With lead wire
LO	L plug connector	Without connector
M	M plug connector	With lead wire
MO	M plug connector	Without connector

Light/surge voltage suppressor

Z	With light/surge voltage suppressor
---	-------------------------------------

How to replace pilot valves

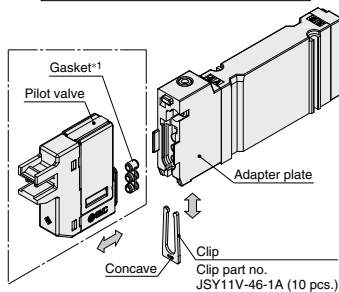

* Clip is not included in the pilot valve.

⚠ Caution

Removal

- 1) Remove the clip from the adapter plate by using a flat head screwdriver on the concave of the clip.
- 2) Remove the pilot valve in the direction of the arrow. (Remove also the gasket together.)

Mounting

- 1) Mount the pilot valve on the adapter plate.
- 2) Insert the clip into the adapter plate so that the clip will not protrude from the end of the adapter plate.

*1 Confirm that the gasket is mounted on the pilot valve.

For JSY3000/5000

V111 □ - 5 □ Z

Coil type

Nil	Standard
T	With power saving circuit (Made to Order)

* Power saving circuit is not available in the case of W□ or WA□ type.

Rated voltage

5	24 VDC
---	--------

Light/surge voltage suppressor

Z	With light/surge voltage suppressor
---	-------------------------------------

Electrical entry

L	L plug connector	With lead wire
LO	L plug connector	Without connector
M	M plug connector	With lead wire
MO	M plug connector	Without connector
WO	M8 connector	Without connector cable
W□	connector	With connector cable
WAO	M8 connector	Without connector cable
WA□	connector	With connector cable

* Refer to "Electrical entry" on page 179 for details on options "WAO" and "WA□".

* For W□ and WA□, enter the cable length symbols in □. Please be sure to fill in the blank referring to page 206.

* The "WAO" and "WA□" M8 connectors are IEC 60947-5-2 standard compliant.

How to replace pilot valves

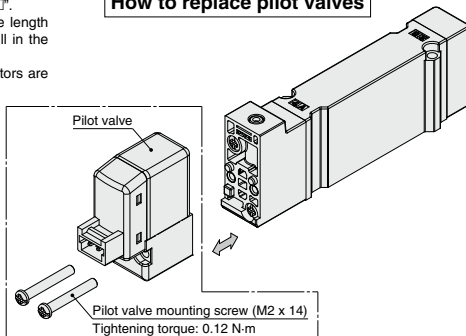

JSY1000/3000/5000 Series Type 40, 41

Non Plug-in Metal Base

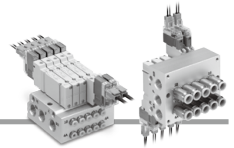

Manifold Specifications

Manifold type			Non plug-in metal base
SUP/EXH port type			Common SUP/EXH
Valve stations			2 to 20 stations
Port size	1(P), 3/5(E) port	JSY1000	1/8
		JSY3000	1/4
		JSY5000	3/8
	4(A), 2(B) port	JSY1000	M3 x 0.5, M5 x 0.8 ø2 One-touch fitting, ø4 One-touch fitting, ø6 One-touch fitting
		JSY3000	M5 x 0.8, 1/8 ø6 One-touch fitting, ø8 One-touch fitting
		JSY5000	1/8, 1/4 ø8 One-touch fitting, ø10 One-touch fitting, ø12 One-touch fitting

Manifold Flow Rate Characteristics/Manifold Weight

Model	Port size		Valve flow rate characteristics				Weight: W [g] ^{*1} (n: stations)	
	1, 5, 3 (P, EA, EB)	4, 2 (A, B)	1 → 4/2 (P → A/B)		4/2 → 5/3 (A/B → E)		Fixed: C□	Replaceable: KC□
			C [dm ³ /(s·bar)]	b	C [dm ³ /(s·bar)]	b		
JJ5SY1-40 (Side ported)	1/8	KC6	0.62	0.34	0.63	0.28	20.1n + 38	30.5n + 35
JJ5SY1-41 (Bottom ported)	1/8	KC6	0.74	0.46	0.75	0.36	20.8n + 38	33.8n + 35
JJ5SY3-40 (Side ported)	1/4	KC8	1.86	0.36	1.81	0.27	38.0n + 84	54.4n + 86
JJ5SY3-41 (Bottom ported)	1/4	KC8	2.31	0.43	2.13	0.31	41.2n + 84	59.6n + 80
JJ5SY5-40 (Side ported)	3/8	KC12	3.61	0.30	3.72	0.18	90.1n + 148	121.5n + 144
JJ5SY5-41 (Bottom ported)	3/8	KC12	4.28	0.40	4.47	0.25	95.8n + 133	140.1n + 122

*1 Weight: W is the value of the internal pilot, and maximum manifold size with tube fitting type. Valve is not included. To obtain the weight with valves attached, add the valve weights given on page 173 for the appropriate number of stations.

* Calculation of effective area S and sonic conductance C: S = 5.0 x C

* The value is for manifold base with 5 stations and individually operated 2-position type.

* Bottom port is available only for 4, 2 (A, B) port.

Type 40
Side Ported

Type 41
Bottom Ported

Non Plug-in Metal Base

JSY1000/3000/5000 Series



Internal Pilot

How to Order Manifolds

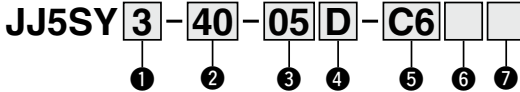

Made to Order Made to Order
(Refer to page 203 for details.)

Specification
External pilot

1 Series

1	JSY1000
3	JSY3000
5	JSY5000

2 Type

40	Side ported
41	Bottom ported

* The external pilot specification should be ordered as Made to Order. For details, refer to page 203.

3 Valve stations

Symbol	Stations
02	2 stations
?	?
20	20 stations

4 P, E port entry

U	U side*1
D	D side*1
B	Both sides

*1 Plugs are mounted on the opposite side of the selected ports.

5 A, B port size
Thread piping

Symbol	A, B port	JSY1000	JSY3000	JSY5000
M3	M3 x 0.5	●	—	—
M5	M5 x 0.8	●	●	—
01	1/8	—	●	●
02	1/4	—	—	●

6 Thread type

Nil	Rc
F	G
N	NPT

7 Mounting

Nil	Direct mounting
D	DIN rail mounting (With DIN rail)
D0	DIN rail mounting (Without DIN rail)
D3	For 3 stations Specify a longer rail than the standard
:	:
D20	For 20 stations length.

* Only direct mounting is available for Type 41 (Bottom ported).
* Refer to page 209 for the fixation of DIN rail mounting type manifold.

One-touch fitting (Metric)

Symbol	A, B port	JSY1000	JSY3000	JSY5000
C2	ø2	●	—	—
C4	ø4	●	—	—
C6	ø6	—	●	—
C8	ø8	—	—	●
KC2	ø2	●	—	—
KC4	ø4	●	—	—
KC6	ø6	●	●	—
KC8	ø8	—	●	—
KC10	ø10	—	—	●
KC12	ø12	—	—	●
M*1	A, B ports mixed	●*2	●	●
P, E port size (Thread piping)		1/8	1/4	3/8

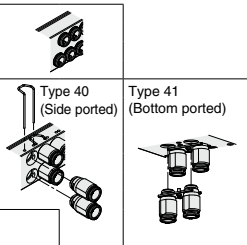

*1 When ports are mixed sizes, indicate the piping specifications on the manifold specification sheet.
*2 In case of replacement of JSY1000 One-touch fitting, A and B port can only be mixed on the manifold base for KC2 and KC4.

How to Order Manifold Assembly

Example (JJ5SY3-40-□)

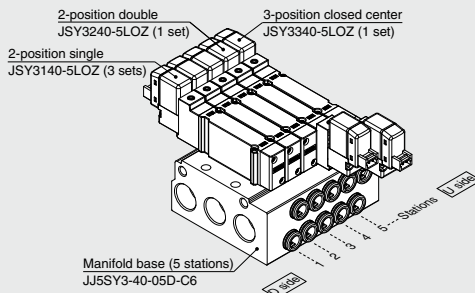

JJ5SY3-40-05D-C6-1 set (Type 40 5-station manifold base part no.)

* JSY3140-5LOZ.....3 sets (2-position single part no.)

* JSY3240-5LOZ.....1 set (2-position double part no.)

* JSY3340-5LOZ.....1 set (3-position closed center part no.)

→ The asterisk denotes the symbol for the assembly. Prefix it to the part numbers of the valve, etc.

The valve arrangement is numbered as the 1st station from the D side. Under the manifold part number, state the valves to be mounted in order from the 1st station as shown in the figure. If the arrangement becomes complicated, specify on a manifold specification sheet.

Internal Pilot

How to Order Valves (With two mounting screws)

JSY1000 Series
JSY3000/5000 Series

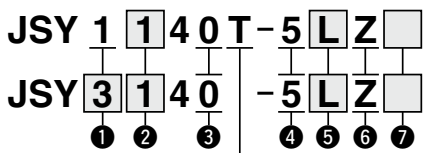

Made to Order
Made to Order
(Refer to page 203 for details.)

Specification
With power saving circuit (Continuous duty type): 0.1 W (JSY3000/5000)
External pilot

1 Series

1	JSY1000
3	JSY3000
5	JSY5000

2 Type of actuation

1	2-position single
2	2-position double
3	3-position closed center
4	3-position exhaust center
5	3-position pressure center
A	Dual 3-port (N.C./N.C.)
B	Dual 3-port (N.O./N.O.)
C	Dual 3-port (N.C./N.O.)

3 Pilot valve exhaust method

0	Pilot valve individual exhaust
---	--------------------------------

4 Rated voltage

5	24 VDC
---	--------

5 Electrical entry

	L plug connector		M plug connector		M8 connector*1			
	L	LO	M	MO	W□	WO	WA□	WAO
JSY1000	L: With lead wire (300 mm) 	LO: Without connector 	M: With lead wire (300 mm) 	MO: Without connector 	—	—	—	—
JSY3000 JSY5000	L: With lead wire (300 mm) 	LO: Without connector 	M: With lead wire (300 mm) 	MO: Without connector 	W□: With connector cable 	WO: Without connector cable 	WA□: With connector cable 	WAO: Without connector cable

*1 Refer to page 206 for the lead wire length of L and M plug connectors.
 *1 The "WAO" and "WA□" M8 connectors are IEC 60947-5-2 standard compliant.
 *1 Refer to page 207 for polarity details and the pin wiring diagram.
 *1 For connector cable of M8 connector, refer to page 206. For W□ and WA□, enter the cable length symbols in □. Please be sure to fill in the blank referring to page 206.

6 Light/surge voltage suppressor

Z	With light/surge voltage suppressor
---	-------------------------------------

7 Manual override

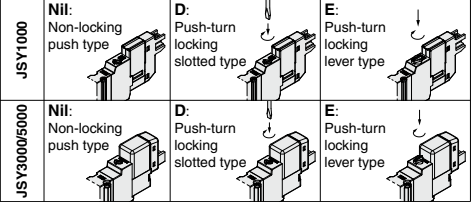

When ordering a valve individually, the base gasket is not included.
 Since the base gasket is attached to the manifold, please order the base gasket separately if it is needed for maintenance service.
 Refer to page 198 for base gasket and mounting screw part numbers.

⚠ Caution
 If the JSY3000/5000 series will be continuously energized, please be sure to use the power saving circuit (continuous duty type). Refer to Made to Order on page 203. Additionally, when it is used at the energizing rate over 50%, please select the product with power saving circuit.
 For the JSY1000 series only the power saving circuit is available.

JSY1000/3000/5000 Series

Dimensions: **JSY1000 Series**

Non Plug-in Metal Base Type 40/Side Ported
Port Size: M3, M5

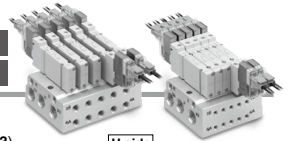

JJ5Y1-40(R)-[Stations] $\frac{D}{B}$ - $\frac{M3}{M5}$ □(D)

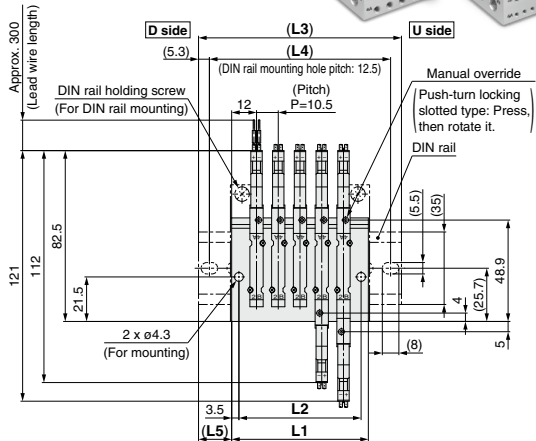
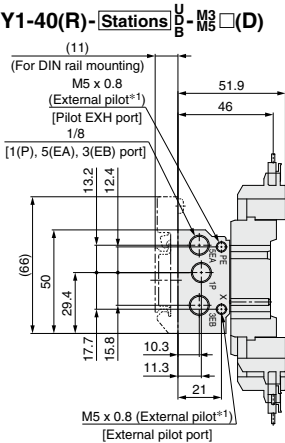

M plug connector (M)

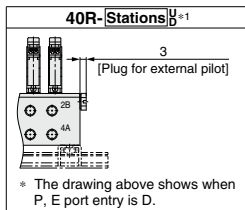
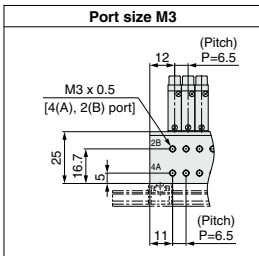
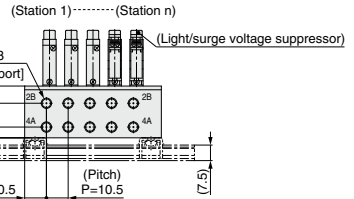
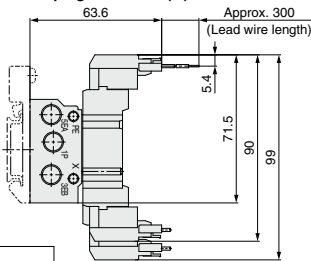

*1 The external pilot (R) should be ordered as Made to Order.
* These figures show the "JJ5Y1-40-05B-M5."

* The drawing above shows when P, E port entry is D.

L Dimensions: Port Size M5

n: Stations

L \ n	2	3	4	5	6	7	8	9	10	11	12	13	14	15	16	17	18	19	20
L1	34.5	45.0	55.5	66.0	76.5	87.0	97.5	108.0	118.5	129.0	139.5	150.0	160.5	171.0	181.5	192.0	202.5	213.0	223.5
L2	27.5	38.0	48.5	59.0	69.5	80.0	90.5	101.0	111.5	122.0	132.5	143.0	153.5	164.0	174.5	185.0	195.5	206.0	216.5
L3	60.5	73.0	85.5	98.0	110.5	123.0	135.5	148.0	160.5	173.0	185.5	198.0	210.5	223.0	235.5	248.0	260.5	273.0	285.5
L4	50.0	62.5	75.0	87.5	100.0	112.5	125.0	137.5	150.0	162.5	175.0	187.5	200.0	212.5	225.0	237.5	250.0	262.5	275.0
L5	13.0	14.0	15.0	16.0	17.0	18.0	19.0	20.0	21.0	22.0	23.0	24.0	25.0	26.0	27.0	28.0	29.0	30.0	31.0

L Dimensions: Port Size M3

n: Stations

L \ n	2	3	4	5	6	7	8	9	10	11	12	13	14	15	16	17	18	19	20
L1	30.5	37.0	43.5	50.0	56.5	63.0	69.5	76.0	82.5	89.0	95.5	102.0	108.5	115.0	121.5	128.0	134.5	141.0	147.5
L2	23.5	30.0	36.5	43.0	49.5	56.0	62.5	69.0	75.5	82.0	88.5	95.0	101.5	108.0	114.5	121.0	127.5	134.0	140.5
L3	60.5	73.0	85.5	98.0	110.5	123.0	135.5	148.0	160.5	173.0	185.5	198.0	210.5	223.0	235.5	248.0	260.5	273.0	285.5
L4	50.0	62.5	75.0	87.5	100.0	112.5	125.0	137.5	150.0	162.5	175.0	187.5	200.0	212.5	225.0	237.5	250.0	262.5	275.0
L5	15.0	18.0	21.0	24.0	27.0	30.0	33.0	36.0	39.0	42.0	45.0	48.0	51.0	54.0	57.0	60.0	63.0	66.0	69.0

Dimensions: **JSY1000 Series**

Non Plug-in Metal Base **Type 41/Bottom Ported**
Port Size: M3, M5

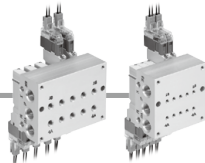

JJ5SY1-41(R)-[Stations]_D - $\frac{M3}{M5}$ □

M plug connector (M)

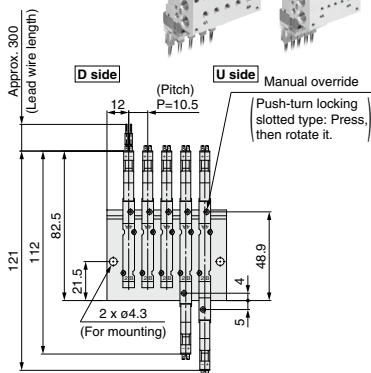
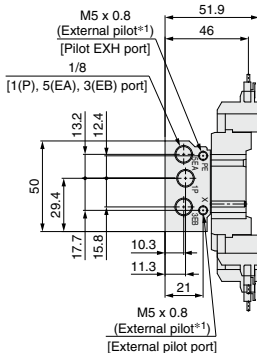
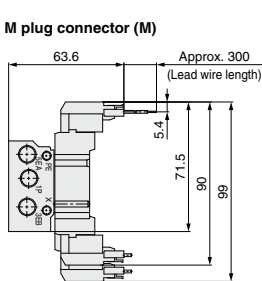

(Station 1).....(Station n)

(Light/surge voltage suppressor)

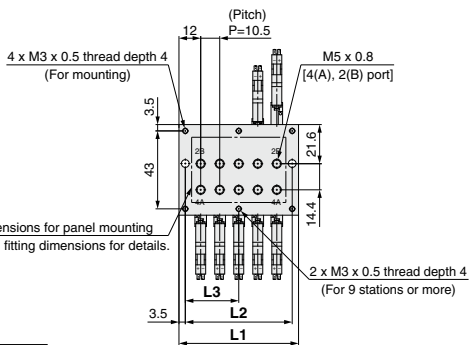

Fitting dimensions for panel mounting
Refer to panel fitting dimensions for details.

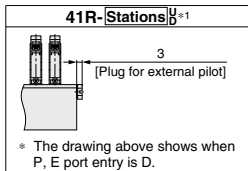
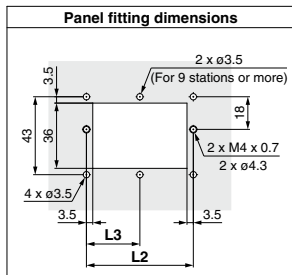
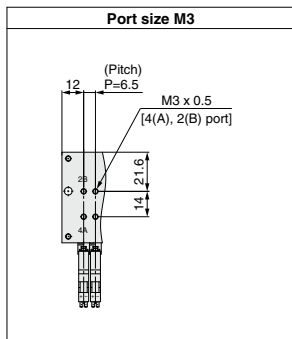

*1 The external pilot (R) should be ordered as Made to Order.
* These figures show the "JJ5SY1-41-05B-M5."

L Dimensions: Port Size M5

n: Stations

L \ n	2	3	4	5	6	7	8	9	10	11	12	13	14	15	16	17	18	19	20
L1	34.5	45.0	55.5	66.0	76.5	87.0	97.5	108.0	118.5	129.0	139.5	150.0	160.5	171.0	181.5	192.0	202.5	213.0	223.5
L2	27.5	38.0	48.5	59.0	69.5	80.0	90.5	101.0	111.5	122.0	132.5	143.0	153.5	164.0	174.5	185.0	195.5	206.0	216.5
L3	—	—	—	—	—	—	—	50.5	55.8	61.0	66.3	71.5	76.8	82.0	87.3	92.5	97.8	103.0	108.3

L Dimensions: Port Size M3

n: Stations

L \ n	2	3	4	5	6	7	8	9	10	11	12	13	14	15	16	17	18	19	20
L1	30.5	37.0	43.5	50.0	56.5	63.0	69.5	76.0	82.5	89.0	95.5	102.0	108.5	115.0	121.5	128.0	134.5	141.0	147.5
L2	23.5	30.0	36.5	43.0	49.5	56.0	62.5	69.0	75.5	82.0	88.5	95.0	101.5	108.0	114.5	121.0	127.5	134.0	140.5
L3	—	—	—	—	—	—	—	34.5	37.8	41.0	44.3	47.5	50.8	54.0	57.3	60.5	63.8	67.0	70.3

JSY1000/3000/5000 Series

Dimensions: **JSY1000 Series**

Non Plug-in Metal Base Type 41/Bottom Ported
Port Size: $\phi 2, \phi 4$ /Fixed

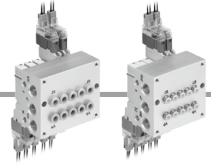

JJ5SY1-41(R)-Stations $\frac{U}{D}$ - C₂ C₄ □

M plug connector (M)

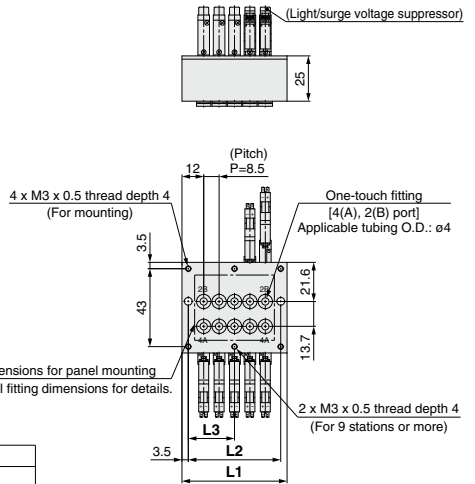
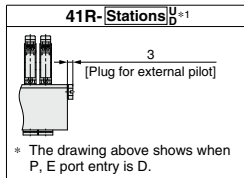
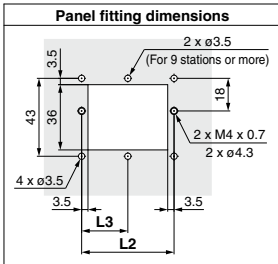
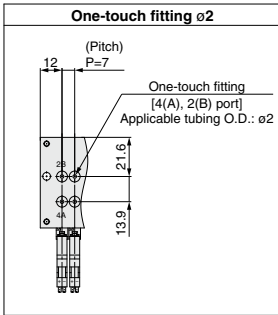
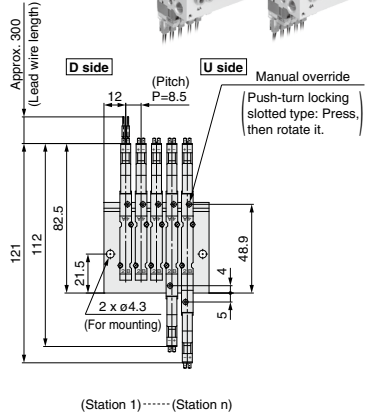
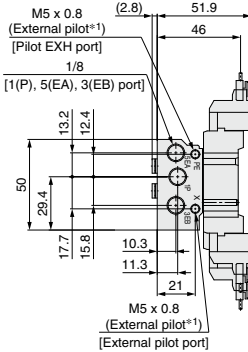
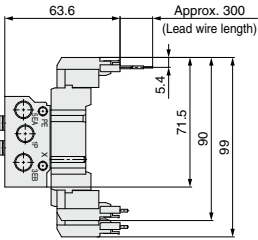

*1 The external pilot (R) should be ordered as Made to Order.
* These figures show the "JJ5SY1-41-05B-C4."

L Dimensions: Port Size C4

L \ n	n: Stations																			
	2	3	4	5	6	7	8	9	10	11	12	13	14	15	16	17	18	19	20	
L1	32.5	41.0	49.5	58.0	66.5	75.0	83.5	92.0	100.5	109.0	117.5	126.0	134.5	143.0	151.5	160.0	168.5	177.0	185.5	
L2	25.5	34.0	42.5	51.0	59.5	68.0	76.5	85.0	93.5	102.0	110.5	119.0	127.5	136.0	144.5	153.0	161.5	170.0	178.5	
L3	—	—	—	—	—	—	—	42.5	46.8	51.0	55.3	59.5	63.8	68.0	72.3	76.5	80.8	85.0	89.3	

L Dimensions: Port Size C2

L \ n	n: Stations																			
	2	3	4	5	6	7	8	9	10	11	12	13	14	15	16	17	18	19	20	
L1	31.0	38.0	45.0	52.0	59.0	66.0	73.0	80.0	87.0	94.0	101.0	108.0	115.0	122.0	129.0	136.0	143.0	150.0	157.0	
L2	24.0	31.0	38.0	45.0	52.0	59.0	66.0	73.0	80.0	87.0	94.0	101.0	108.0	115.0	122.0	129.0	136.0	143.0	150.0	
L3	—	—	—	—	—	—	—	36.5	40.0	43.5	47.0	50.5	54.0	57.5	61.0	64.5	68.0	71.5	75.0	

Dimensions: **JSY1000 Series**

Non Plug-in Metal Base Type 41/Bottom Ported
Port Size: ø2, ø4, ø6/Replaceable

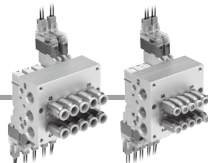

JJ5SY1-41(R)-[Stations] $\begin{matrix} \text{U} \\ \text{D} \\ \text{B} \end{matrix}$ $\begin{matrix} \text{KC2} \\ \text{KC4} \\ \text{KC6} \end{matrix}$

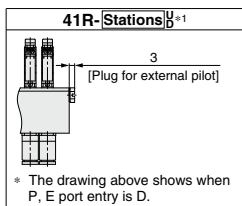
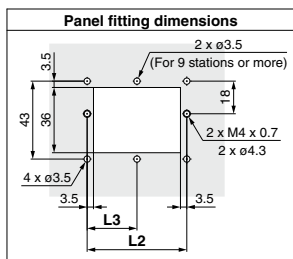
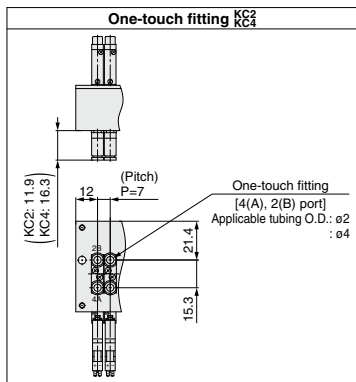
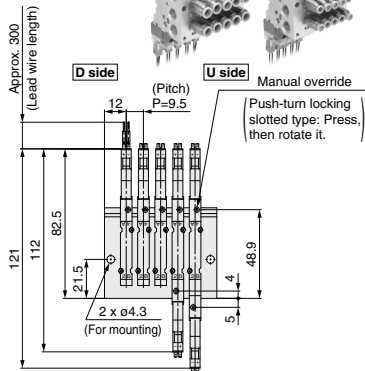
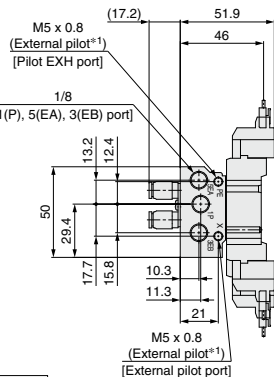
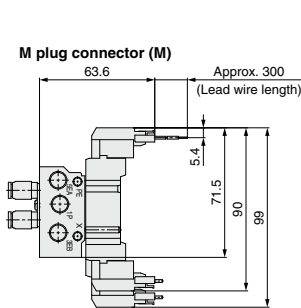

(Station 1) (Station n)

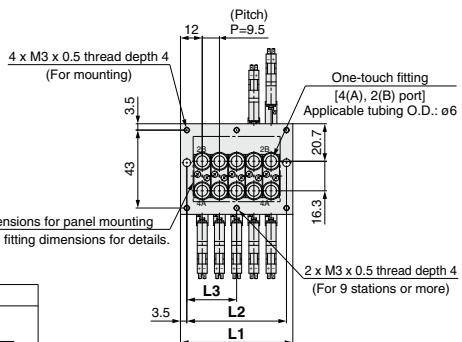
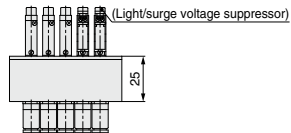

Fitting dimensions for panel mounting
Refer to panel fitting dimensions for details.

L Dimensions: Port Size KC6

n: Stations

L \ n	2	3	4	5	6	7	8	9	10	11	12	13	14	15	16	17	18	19	20
L1	33.5	43.0	52.5	62.0	71.5	81.0	90.5	100.0	109.5	119.0	128.5	138.0	147.5	157.0	166.5	176.0	185.5	195.0	204.5
L2	26.5	36.0	45.5	55.0	64.5	74.0	83.5	93.0	102.5	112.0	121.5	131.0	140.5	150.0	159.5	169.0	178.5	188.0	197.5
L3	—	—	—	—	—	—	—	46.5	51.3	56.0	60.8	65.5	70.3	75.0	79.8	84.5	89.3	94.0	98.8

L Dimensions: Port Sizes KC2, KC4

n: Stations

L \ n	2	3	4	5	6	7	8	9	10	11	12	13	14	15	16	17	18	19	20
L1	31.0	38.0	45.0	52.0	59.0	66.0	73.0	80.0	87.0	94.0	101.0	108.0	115.0	122.0	129.0	136.0	143.0	150.0	157.0
L2	24.0	31.0	38.0	45.0	52.0	59.0	66.0	73.0	80.0	87.0	94.0	101.0	108.0	115.0	122.0	129.0	136.0	143.0	150.0
L3	—	—	—	—	—	—	—	36.5	40.0	43.5	47.0	50.5	54.0	57.5	61.0	64.5	68.0	71.5	75.0

JSY1000/3000/5000 Series

Dimensions: JSY3000 Series

Non Plug-in Metal Base **Type 40/Side Ported**
Port Size: M5, 1/8

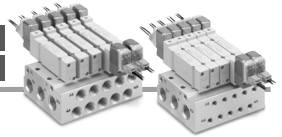

JJ5SY3-40(R)-Stations_D^U M5 □ (D)

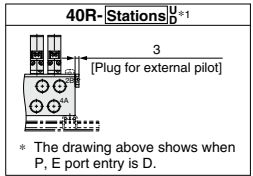
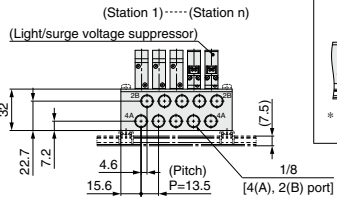
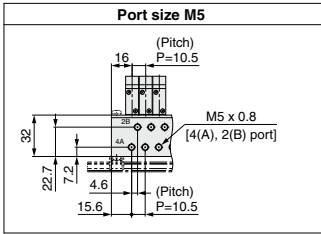
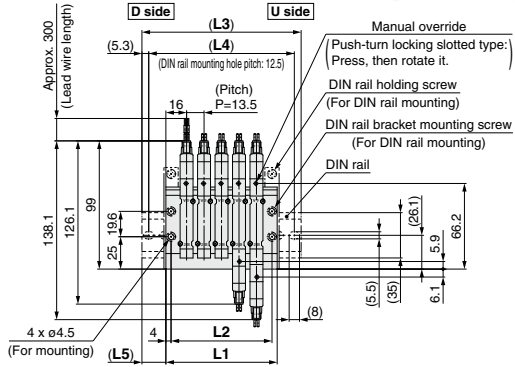
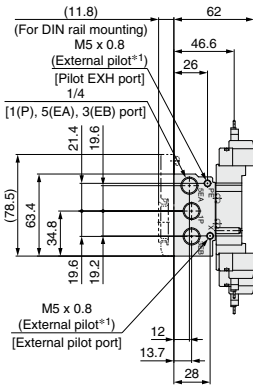

* The drawing above shows when P, E port entry is D.

*1 The external pilot (R) should be ordered as Made to Order.
 * These figures show the "JJ5SY3-40-05-01."

M plug connector (M)

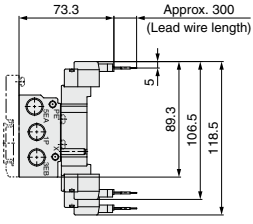

M8 connector (W, WA)

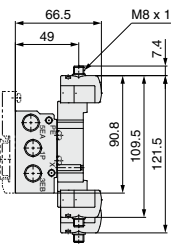

L Dimensions: Port Size 01 (1/8)

n: Stations

L \ n	2	3	4	5	6	7	8	9	10	11	12	13	14	15	16	17	18	19	20
L1	45.5	59.0	72.5	86.0	99.5	113.0	126.5	140.0	153.5	167.0	180.5	194.0	207.5	221.0	234.5	248.0	261.5	275.0	288.5
L2	37.5	51.0	64.5	78.0	91.5	105.0	118.5	132.0	145.5	159.0	172.5	186.0	199.5	213.0	226.5	240.0	253.5	267.0	280.5
L3	73.0	85.5	110.5	123.0	135.5	148.0	160.5	173.0	185.5	198.0	210.5	223.0	235.5	248.0	273.0	285.5	298.0	310.5	323.0
L4	62.5	75.0	100.0	112.5	125.0	137.5	150.0	162.5	175.0	187.5	200.0	212.5	225.0	237.5	262.5	275.0	287.5	300.0	312.5
L5	14.0	13.5	19.0	18.5	18.0	17.5	17.0	16.5	16.0	15.5	15.0	14.5	14.0	13.5	19.5	19.0	18.5	18.0	17.5

L Dimensions: Port Size M5

n: Stations

L \ n	2	3	4	5	6	7	8	9	10	11	12	13	14	15	16	17	18	19	20
L1	42.5	53.0	63.5	74.0	84.5	95.0	105.5	116.0	126.5	137.0	147.5	158.0	168.5	179.0	189.5	200.0	210.5	221.0	231.5
L2	34.5	45.0	55.5	66.0	76.5	87.0	97.5	108.0	118.5	129.0	139.5	150.0	160.5	171.0	181.5	192.0	202.5	213.0	223.5
L3	73.0	85.5	98.0	110.5	123.0	135.5	148.0	160.5	173.0	185.5	198.0	210.5	223.0	235.5	248.0	260.5	273.0	285.5	298.0
L4	62.5	75.0	87.5	100.0	112.5	125.0	137.5	150.0	162.5	175.0	187.5	200.0	212.5	225.0	237.5	250.0	262.5	275.0	287.5
L5	15.5	16.5	17.5	18.5	19.5	20.5	21.5	22.5	23.5	24.5	25.5	26.5	27.5	28.5	29.5	30.5	31.5	32.5	33.5

Dimensions: JSY3000 Series

Non Plug-in Metal Base Type 40/Side Ported
Port Size: ø6/Fixed

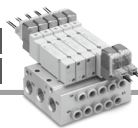

JJ5SY3-40(R)-Stations $\frac{D}{B}$ - C6 □ (D)

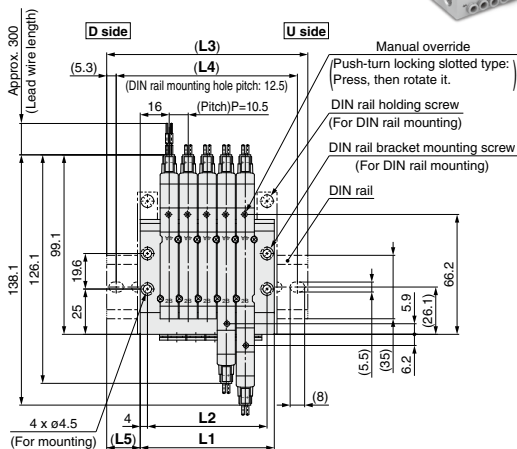
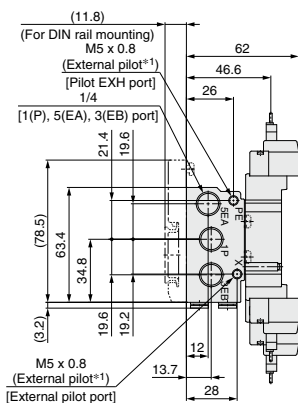

(Station 1) (Station n)
(Light/surge voltage suppressor)

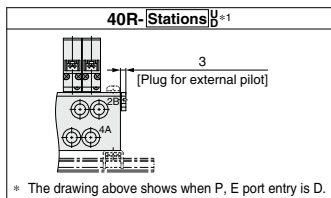
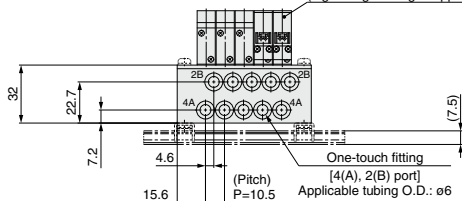

*1 The external pilot (R) should be ordered as Made to Order.
* These figures show the "JJ5SY3-40-05-C6."

M plug connector (M)

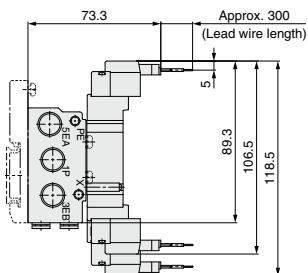

M8 connector (W, WA)

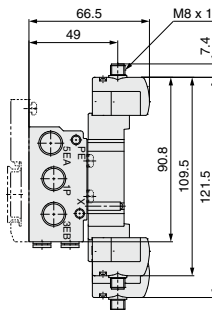

L Dimensions: Port Size C6

L	n	n: Stations																		
		2	3	4	6	7	8	9	10	11	12	13	14	15	16	17	18	19	20	
L1		42.5	53.0	63.5	74.0	84.5	95.0	105.5	116.0	126.5	137.0	147.5	158.0	168.5	179.0	189.5	200.0	210.5	221.0	231.5
L2		34.5	45.0	55.5	66.0	76.5	87.0	97.5	108.0	118.5	129.0	139.5	150.0	160.5	171.0	181.5	192.0	202.5	213.0	223.5
L3		73.0	85.5	98.0	110.5	123.0	135.5	148.0	160.5	173.0	185.5	198.0	210.5	223.0	235.5	248.0	260.5	273.0	285.5	298.0
L4		62.5	75.0	87.5	100.0	112.5	125.0	137.5	150.0	162.5	175.0	187.5	200.0	212.5	225.0	237.5	250.0	262.5	275.0	287.5
L5		15.5	16.5	17.5	18.5	19.5	20.5	21.5	22.5	23.5	24.5	25.5	26.5	27.5	28.5	29.5	30.5	31.5	32.5	33.5

JSY1000/3000/5000 Series

Dimensions: JSY3000 Series

Non Plug-in Metal Base **Type 40/Side Ported**
 Port Size: ø6, ø8/Replaceable

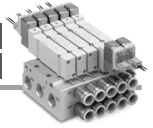

JJ5SY3-40(R)-[Stations] $\frac{D}{B}$ - KC6 KC8 □ (D)

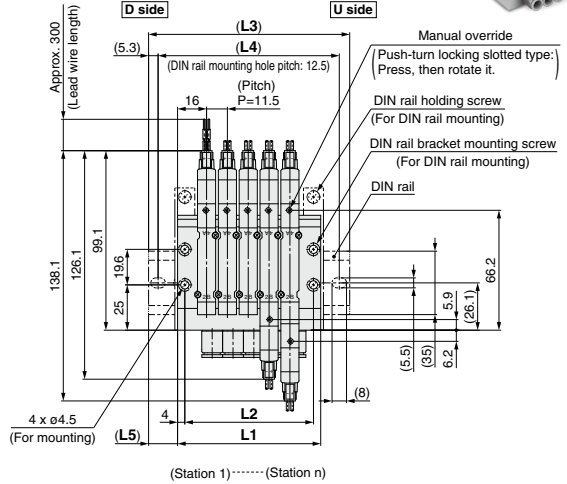
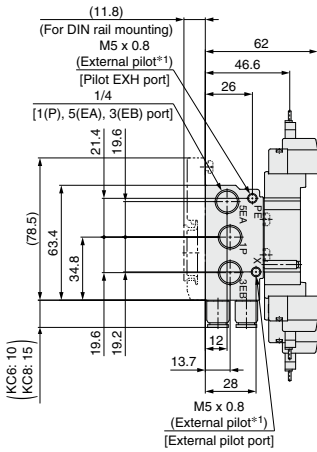

(Station 1).....(Station n)

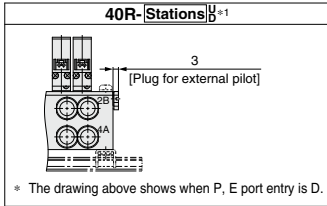
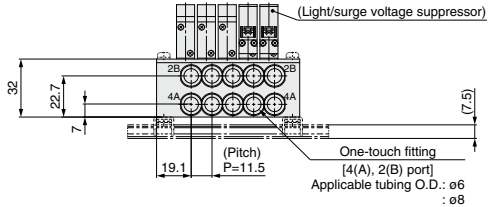

*1 The external pilot (R) should be ordered as Made to Order.
 * These figures show the "JJ5SY3-40-05-KC8."

M plug connector (M)

M8 connector (W, WA)

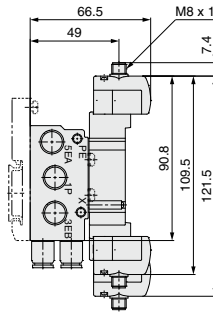
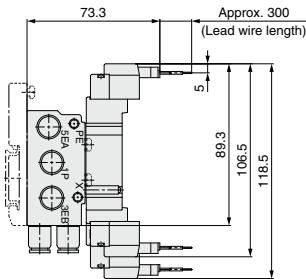

L Dimensions: Port Sizes KC6, KC8

L \ n	n: Stations																			
	2	3	4	5	6	7	8	9	10	11	12	13	14	15	16	17	18	19	20	
L1	44.5	56.0	67.5	79.0	90.5	102.0	113.5	125.0	136.5	148.0	159.5	171.0	182.5	194.0	205.5	217.0	228.5	240.0	251.5	
L2	36.5	48.0	59.5	71.0	82.5	94.0	105.5	117.0	128.5	140.0	151.5	163.0	174.5	186.0	197.5	209.0	220.5	232.0	243.5	
L3	73.0	85.5	98.0	110.5	123.0	135.5	148.0	160.5	173.0	185.5	198.0	210.5	223.0	235.5	248.0	260.5	273.0	285.5	298.0	
L4	62.5	75.0	87.5	100.0	112.5	125.0	137.5	150.0	162.5	175.0	187.5	187.5	200.0	212.5	225.0	237.5	250.0	262.5	275.0	
L5	14.5	15.0	15.5	16.0	16.5	17.0	17.5	18.0	18.5	19.0	19.5	13.5	14.0	14.5	15.0	15.5	16.0	16.5	17.0	

Dimensions: JSY3000 Series

Non Plug-in Metal Base Type 41/Bottom Ported
Port Size: ø6, ø8/Replaceable

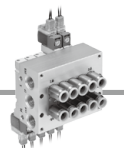

JJ5SY3-41(R)-[Stations]_D - KC6, KC8

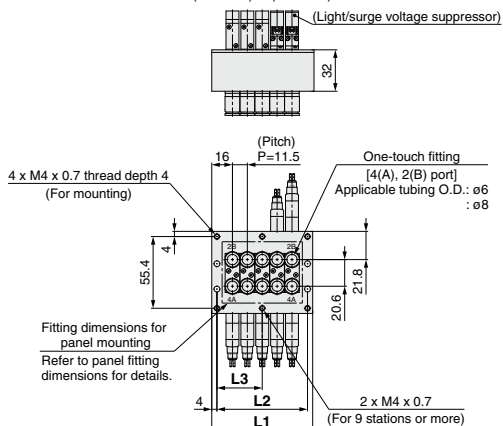
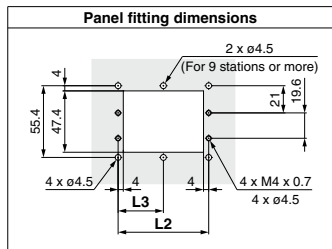
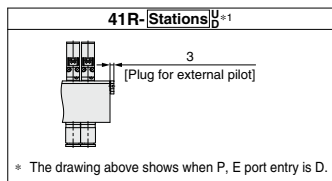
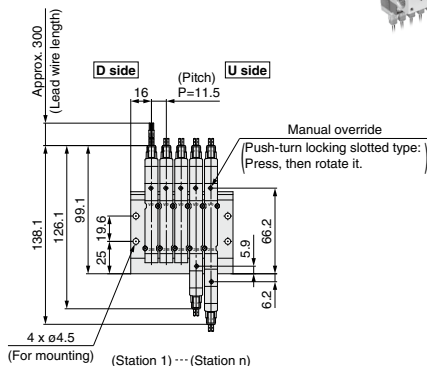
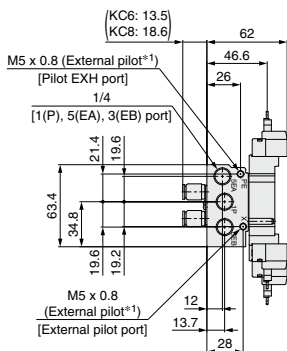

*1 The external pilot (R) should be ordered as Made to Order.
 * These figures show the "JJ5SY3-41-05-KC8."

M plug connector (M)

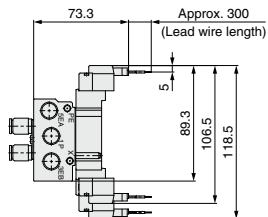

M8 connector (W, WA)

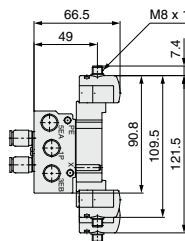

L Dimensions: Port Sizes KC6, KC8

n: Stations

L \ n	2	3	4	5	6	7	8	9	10	11	12	13	14	15	16	17	18	19	20
L1	43.5	55.0	66.5	78.0	89.5	101.0	112.5	124.0	135.5	147.0	158.5	170.0	181.5	193.0	204.5	216.0	227.5	239.0	250.5
L2	35.5	47.0	58.5	70.0	81.5	93.0	104.5	116.0	127.5	139.0	150.5	162.0	173.5	185.0	196.5	208.0	219.5	231.0	242.5
L3	—	—	—	—	—	—	—	58.0	63.8	69.5	75.3	81.0	86.8	92.5	98.3	104.0	109.8	115.5	121.3

JSY1000/3000/5000 Series

Non Plug-in Metal Base **Type 40/Side Ported**
Port Size: ø10, ø12/Replaceable

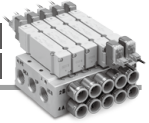

Dimensions: JSY5000 Series

JJ5SY5-40(R)-[Stations]_D - KC10 □ KC12 □ (D)

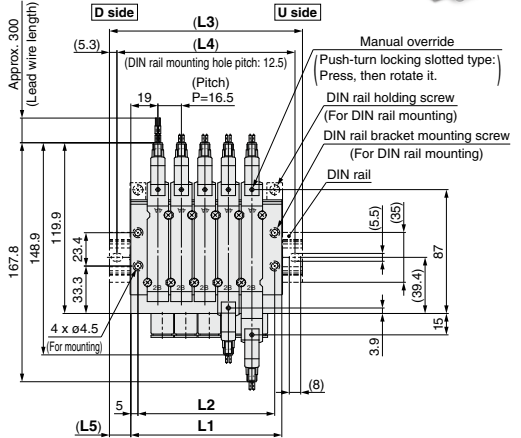
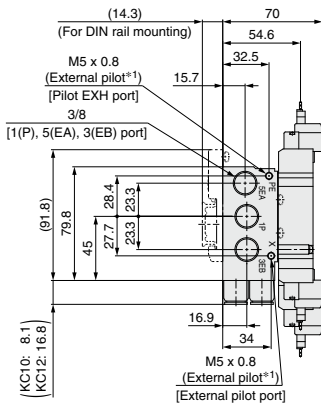

(Station 1) (Station n)

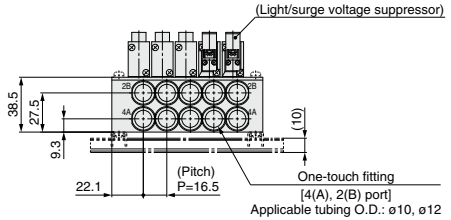
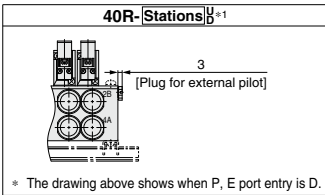

*1 The external pilot (R) should be ordered as Made to Order.
 * These figures show the "JJ5SY5-40-05B-KC12."

M plug connector (M)

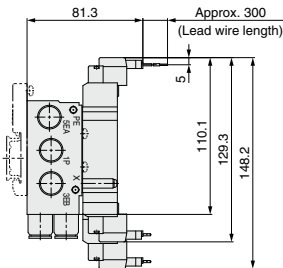

M8 connector (W, WA)

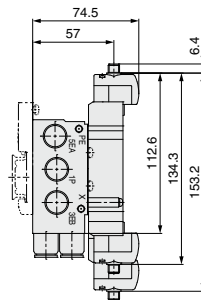

L Dimensions: Port Sizes KC10, KC12

L \ n	2	3	4	5	6	7	8	9	10	11	12	13	14	15	16	17	18	19	20
L1	56.5	73.0	89.5	106.0	122.5	139.0	155.5	172.0	188.5	205.0	221.5	238.0	254.5	271.0	287.5	304.0	320.5	337.0	353.5
L2	46.5	63.0	79.5	96.0	112.5	129.0	145.5	162.0	178.5	195.0	211.5	228.0	244.5	261.0	277.5	294.0	310.5	327.0	343.5
L3	85.5	98.0	123.0	135.5	148.0	173.0	185.5	198.0	223.0	235.5	248.0	273.0	285.5	298.0	323.0	335.5	348.0	373.0	385.5
L4	75.0	87.5	112.5	125.0	137.5	162.5	175.0	187.5	212.5	225.0	237.5	262.5	275.0	287.5	312.5	325.0	337.5	362.5	375.0
L5	14.5	12.5	17.0	15.0	13.0	17.0	15.0	13.0	17.5	15.5	13.5	17.5	15.5	13.5	18.0	16.0	14.0	18.0	16.0



Dimensions: JSY5000 Series

Non Plug-in Metal Base Type 41/Bottom Ported
Port Size: 1/8, 1/4

JJ5SY5-41(R)-[Stations] $\frac{D}{B}$ - 01 \square 02 \square

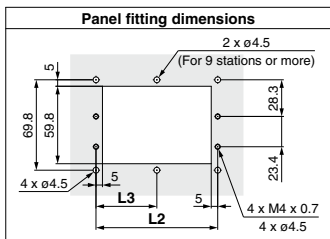
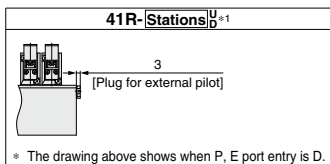
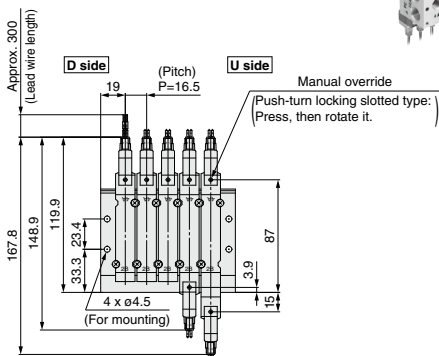
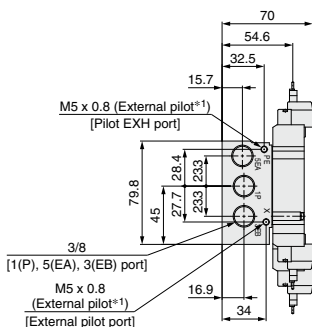

*1 The external pilot (R) should be ordered as Made to Order.
* These figures show the "JJ5SY5-41-05B-02."

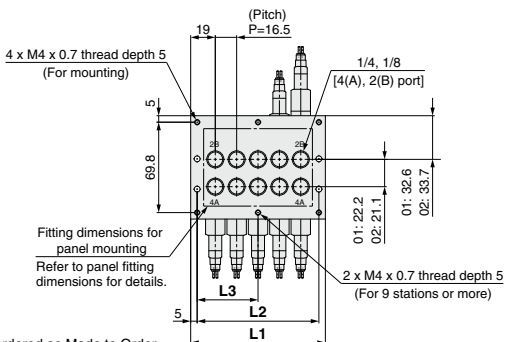
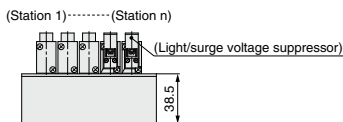

Fitting dimensions for panel mounting
Refer to panel fitting dimensions for details.

M plug connector (M)

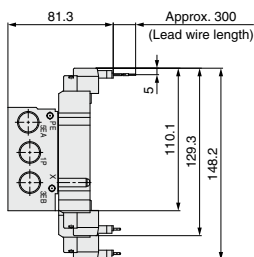

M8 connector (W, WA)

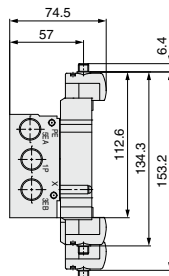

L Dimensions: Port Sizes 01 (1/8), 02 (1/4)

n: Stations

L	n	2	3	4	5	6	7	8	9	10	11	12	13	14	15	16	17	18	19	20
L1		54.5	71.0	87.5	104.0	120.5	137.0	153.5	170.0	186.5	203.0	219.5	236.0	252.5	269.0	285.5	302.0	318.5	335.0	351.5
L2		44.5	61.0	77.5	94.0	110.5	127.0	143.5	160.0	176.5	193.0	209.5	226.0	242.5	259.0	275.5	292.0	308.5	325.0	341.5
L3		—	—	—	—	—	—	—	80.0	88.3	96.5	104.8	113.0	121.3	129.5	137.8	146.0	154.3	162.5	170.8

JSY1000/3000/5000 Series

Dimensions: JSY5000 Series

Non Plug-in Metal Base | **Type 41/Bottom Ported**
Port Size: ø8/Fixed

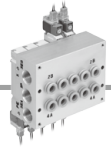

JJ5SY5-41(R)-Stations $\frac{U}{D}$ B-C8 □

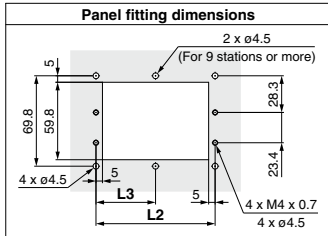
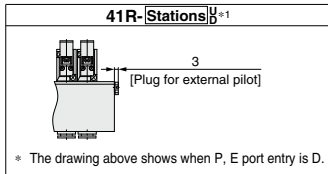
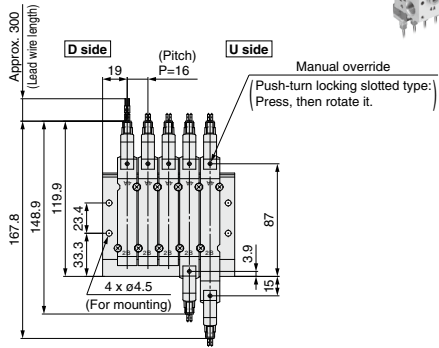
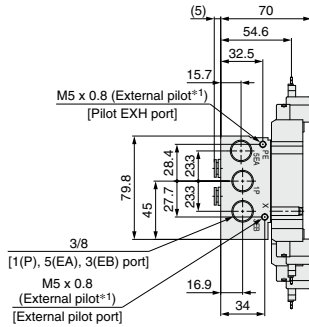

*1 The external pilot (R) should be ordered as Made to Order.
 * These figures show the "JJ5SY5-41-05B-C8."

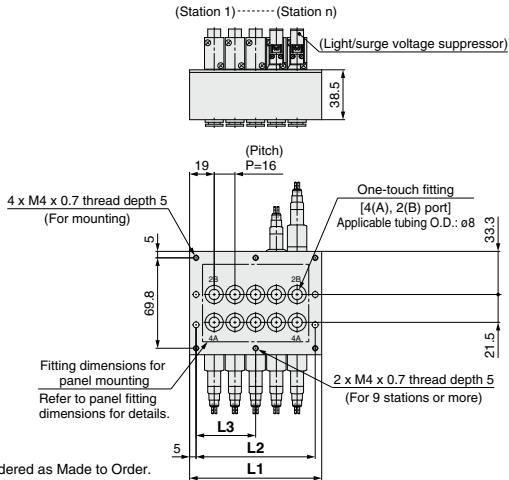

M plug connector (M)

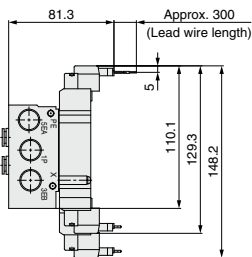

M8 connector (W, WA)

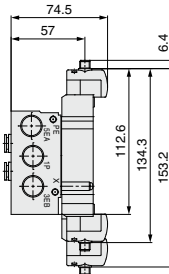

L Dimensions: Port Size C8

n: Stations

L \ n	2	3	4	5	6	7	8	9	10	11	12	13	14	15	16	17	18	19	20
L1	54.0	70.0	86.0	102.0	118.0	134.0	150.0	166.0	182.0	198.0	214.0	230.0	246.0	262.0	278.0	294.0	310.0	326.0	342.0
L2	44.0	60.0	76.0	92.0	108.0	124.0	140.0	156.0	172.0	188.0	204.0	220.0	236.0	252.0	268.0	284.0	300.0	316.0	332.0
L3	—	—	—	—	—	—	—	78.0	86.0	94.0	102.0	110.0	118.0	126.0	134.0	142.0	150.0	158.0	166.0

Non Plug-in Metal Base Type 41/Bottom Ported
Port Size: ø10, ø12/Replaceable



Dimensions: JSY5000 Series

JJ5SY5-41(R)-[Stations]_B U_B KC10 KC12 □

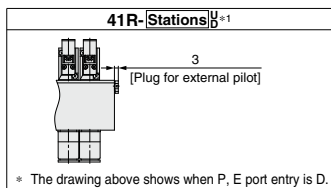
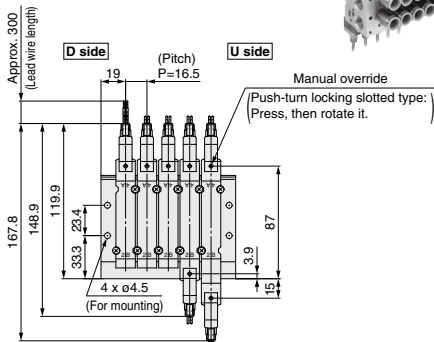
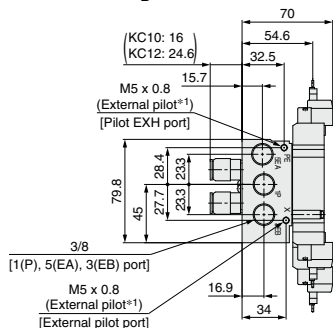

* The drawing above shows when P, E port entry is D.

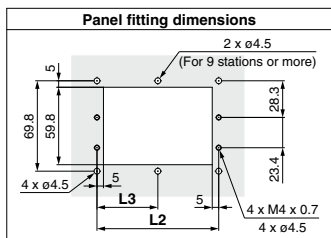

*1 The external pilot (R) should be ordered as Made to Order.
* These figures show the "JJ5SY5-41-05B-KC12."

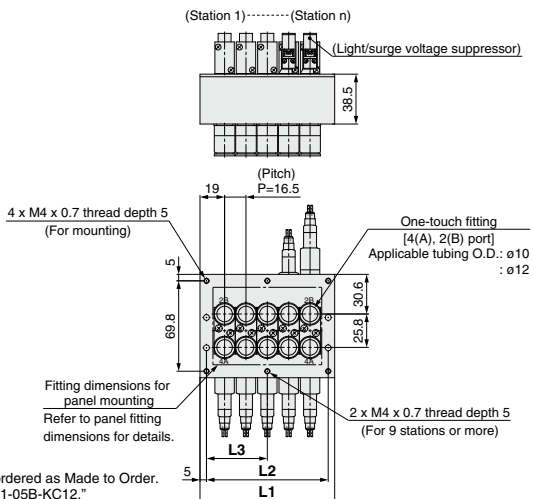

M plug connector (M)

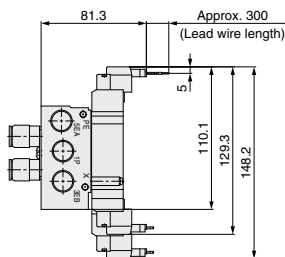

M8 connector (W, WA)

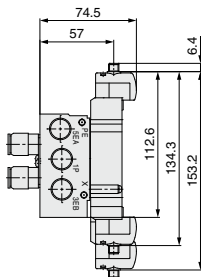

L Dimensions: Port Sizes KC10, KC12

n: Stations

L	n	2	3	4	5	6	7	8	9	10	11	12	13	14	15	16	17	18	19	20
L1		54.5	71.0	87.5	104.0	120.5	137.0	153.5	170.0	186.5	203.0	219.5	236.0	252.5	269.0	285.5	302.0	318.5	335.0	351.5
L2		44.5	61.0	77.5	94.0	110.5	127.0	143.5	160.0	176.5	193.0	209.5	226.0	242.5	259.0	275.5	292.0	308.5	325.0	341.5
L3		—	—	—	—	—	—	80.0	88.3	96.5	104.8	113.0	121.3	129.5	137.8	146.0	154.3	162.5	170.8	—

JSY1000/3000/5000 Series Type 40, 41

Non Plug-in Metal Base Manifold Exploded View

<JSY1000 series>

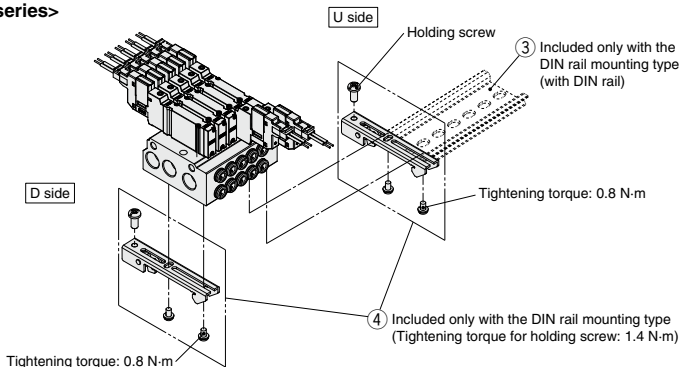

<JSY3000/5000 series>

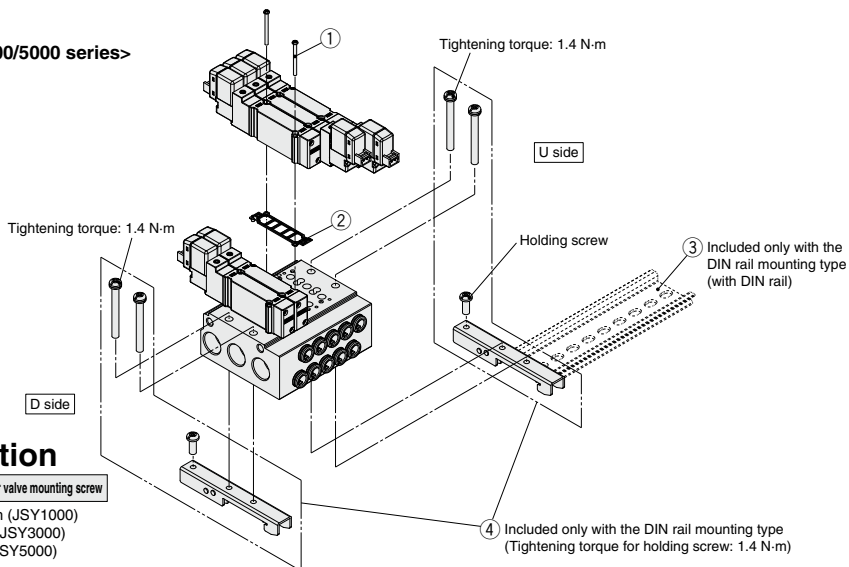

Caution

Tightening torque for valve mounting screw

M1.4: 0.06 N-m (JSY1000)
M2: 0.16 N-m (JSY3000)
M3: 0.8 N-m (JSY5000)

Manifold Parts Nos.

No.	Description	Part number			Note
		JSY1000	JSY3000	JSY5000	
①	Valve mounting screw	JSY11V-23-1A (M1.4 x 21.5)	JSY31V-23-4A (M2 x 22)	JSY51V-23-4A (M3 x 27)	Part numbers shown on the left are for 10 valves. (20 pcs.)
②	Base gasket	JSY11M-11-1A	JSY31M-11-1A	JSY51M-11-1A	Part numbers shown on the left are for 10 valves. (10 pcs.)
③	DIN rail	VZ1000-11-1-□	VZ1000-11-1-□	VZ1000-11-4-□	Refer to page 200.
④	Clamp bracket	JSY11M-15-1A	JSY31M-15-1A	JSY51M-15-1A	Part numbers shown on the left are for one manifold. (2 sets of clamp brackets)

JSY1000/3000/5000 Series

One-touch Fittings, Clip, Port Plate, Tube Releasing Tool

Refer to "How to Replace One-touch Fittings" on page 208 for the replacement method.

■ One-touch Fittings

Port size	JSY1000	JSY3000	JSY5000	Note	
A, B port	ø2	KQSY10-C2	—	Part number is for one piece. (Sales unit: 10 pcs.)	
	ø4	KQSY10-C4-X1336	KQSY30-C4		
	ø6	KQSY11-C6-X1336	KQSY30-C6		KQSY50-C6
	ø8	—	KQSY30-C8-X1336		KQSY50-C8
	ø10	—	—		KQSY50-C10
	ø12	—	—		KQSY50-C12-X1336

■ Clip, Port Plate

	JSY1000		JSY3000	JSY5000	Note
	For A, B port C2/C4 fittings	For A, B port C6 fittings			
Clip	JSY11M-19-4A	JSY11M-19-3A	JSY31M-19-3A	JSY51M-19-3A	Part number is for 10 pieces.
Port plate	JSY11M-10-4A	JSY11M-10-3A	JSY31M-10-3A	JSY51M-10-3A	Part number is for 10 pieces.

■ Tube Releasing Tool (This tool is used for removing the tube from port A and B.)

Series	For JSY1000 (6.5 mm pitch)	For JSY1000 (9 mm pitch) For JSY3000	For JSY5000
Releasing tool part no.	TG-0204	TG-0608	TG-1012
Applicable tubing O.D.	ø2/ø4	ø6/ø8	ø10/ø12

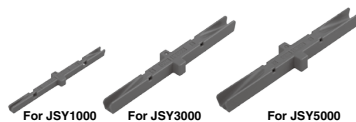

Tube removal procedure

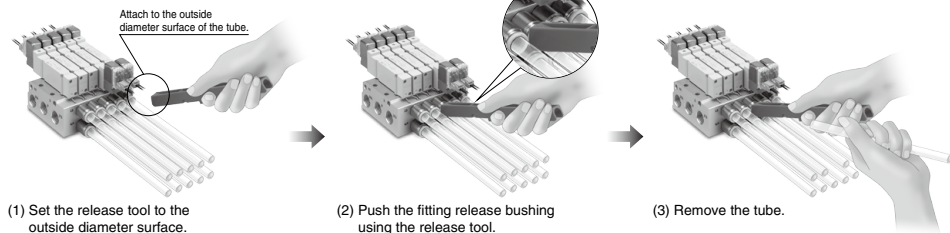

JSY1000/3000/5000 Series Manifold Options

■ DIN rail dimensions/weight for the JSY1000/3000 (Non Plug-in) metal base

VZ1000-11-1-□

* After confirming the L3 dimension in the dimensions table of each series, refer to the DIN rail dimensions table below and specify the number in the box □.

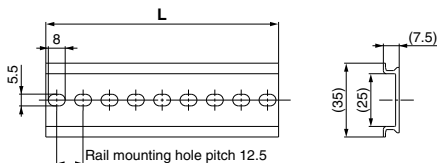

No.	S3	S2	S1	0	1	2	3	4	5	6	7	8	9	10	11	12	13	14	15
L dimension	60.5	73	85.5	98	110.5	123	135.5	148	160.5	173	185.5	198	210.5	223	235.5	248	260.5	273	285.5
Weight [g]	10.9	13.1	15.4	17.6	19.9	22.1	24.4	26.6	28.9	31.1	33.4	35.6	37.9	40.1	42.4	44.6	46.9	49.1	51.4
No.	16	17	18	19	20	21	22	23	24	25	26	27	28	29	30	31	32	33	34
L dimension	298	310.5	323	335.5	348	360.5	373	385.5	398	410.5	423	435.5	448	460.5	473	485.5	498	510.5	523
Weight [g]	53.6	55.9	58.1	60.4	62.5	64.9	67.1	69.4	71.6	73.9	76.1	78.4	80.6	82.9	85.1	87.4	89.6	91.9	94.1
No.	35	36	37	38	39	40	41	42	43	44	45	46	47	48	49	50	51	52	53
L dimension	535.5	548	560.5	573	585.5	598	610.5	623	635.5	648	660.5	673	685.5	698	710.5	723	735.5	748	760.5
Weight [g]	96.4	98.6	100.9	103.1	105.4	107.6	109.9	112.1	114.4	116.6	118.9	121.1	123.4	125.6	127.9	130.1	132.4	134.6	136.9
No.	54	55	56	57	58	59	60	61	62	63	64	65	66	67	68	69	70	71	
L dimension	773	785.5	798	810.5	823	835.5	848	860.5	873	885.5	898	910.5	923	935.5	948	960.5	973	985.5	
Weight [g]	139.1	141.4	143.6	145.9	148.1	150.4	152.6	154.9	157.1	159.4	161.6	163.9	166.1	168.4	170.6	172.9	175.1	177.4	

■ DIN rail dimensions/weight for the JSY5000 (Non Plug-in) metal base

VZ1000-11-4-□

* After confirming the L3 dimension in the dimensions table of each series, refer to the DIN rail dimensions table below and specify the number in the box □.

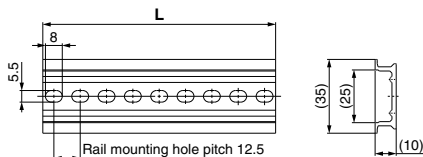

No.	S1	0	1	2	3	4	5	6	7	8	9	10	11	12	13	14	15	16	17
L dimension	85.5	98	110.5	123	135.5	148	160.5	173	185.5	198	210.5	223	235.5	248	260.5	273	285.5	298	310.5
Weight [g]	21.7	24.8	28	31.1	34.3	37.4	40.6	43.8	46.9	50.1	53.3	56.4	59.6	62.7	65.9	69.1	72.2	75.4	78.6
No.	18	19	20	21	22	23	24	25	26	27	28	29	30	31	32	33	34	35	36
L dimension	323	335.5	348	360.5	373	385.5	398	410.5	423	435.5	448	460.5	473	485.5	498	510.5	523	535.5	548
Weight [g]	81.7	84.9	88	91.2	94.4	97.5	100.7	103.9	107	110.2	113.3	116.5	119.7	122.8	126	129.2	132.3	135.5	138.6
No.	37	38	39	40	41	42	43	44	45	46	47	48	49	50	51	52	53	54	55
L dimension	560.5	573	585.5	598	610.5	623	635.5	648	660.5	673	685.5	698	710.5	723	735.5	748	760.5	773	785.5
Weight [g]	141.8	145	148.1	151.3	154.5	157.6	160.8	163.9	167.1	170.3	173.4	176.6	179.8	182.9	186.1	189.2	192.4	195.6	198.7
No.	56	57	58	59	60	61	62	63	64	65	66	67	68	69	70	71			
L dimension	798	810.5	823	835.5	848	860.5	873	885.5	898	910.5	923	935.5	948	960.5	973	985.5			
Weight [g]	201.9	205.1	208.2	211.4	214.5	217.7	220.9	224	227.2	230.4	233.5	236.7	239.8	243	246.2	249.3			



Tightening torque for mounting screw	
M1.4:	0.06 N·m (JSY1000)
M2:	0.16 N·m (JSY3000)
M3:	0.8 N·m (JSY5000)

* Refer to page 202 for dimensions.

Manifold Options

■ Blanking plate

[With two mounting screws]

Used when valve additions are expected or for maintenance.

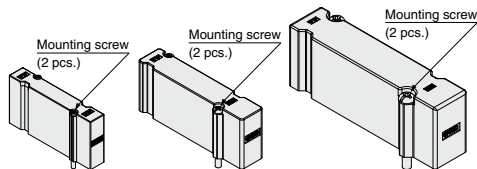

JSY11M-26-1A

JSY31M-26-1A

JSY51M-26-1A

How to Order Blanking Plates

JSY **3** 1M - 26 - 1A

● Series

1	JSY1000
3	JSY3000
5	JSY5000

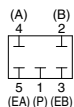

Circuit diagram

■ Individual SUP spacer

[With a base gasket and two mounting screws]

When the same manifold is used for different pressures, an individual SUP spacer is used as a supply port for different pressures.

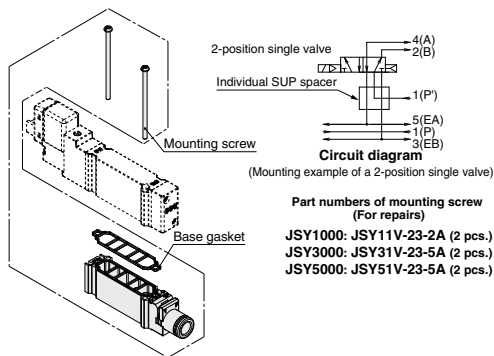

(Mounting example of a 2-position single valve)

Part numbers of mounting screw (For repairs)

JSY1000: JSY11V-23-2A (2 pcs.)
 JSY3000: JSY31V-23-5A (2 pcs.)
 JSY5000: JSY51V-23-5A (2 pcs.)

How to Order Individual SUP/EXH Spacers

JSY **3** 1M - **38** - 1A - **C6**

● Spacer type

38	Individual SUP spacer
39	Individual EXH spacer

● Series

1	JSY1000
3	JSY3000
5	JSY5000

Port size (One-touch fittings)

Symbol	P, E port	JSY1000	JSY3000	JSY5000
C4	ø4 One-touch fitting	●	—	—
C6	ø6 One-touch fitting	—	●	—
C8	ø8 One-touch fitting	—	—	●
C10	ø10 One-touch fitting	—	—	●
C12	ø12 One-touch fitting	—	—	●

■ Individual EXH spacer

[With a base gasket and two mounting screws]

When valve exhaust affects other stations due to the circuit configuration, this spacer is used for individual valve exhaust.

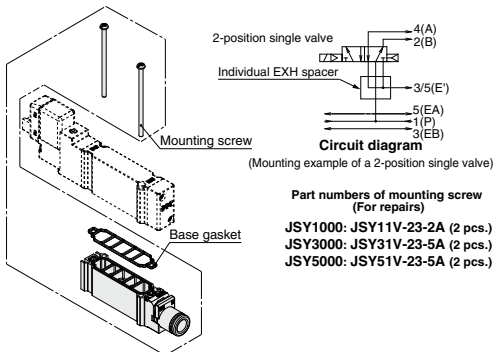

(Mounting example of a 2-position single valve)

Part numbers of mounting screw (For repairs)

JSY1000: JSY11V-23-2A (2 pcs.)
 JSY3000: JSY31V-23-5A (2 pcs.)
 JSY5000: JSY51V-23-5A (2 pcs.)

JSY1000/3000/5000 Series

Dimensions: Manifold Options

■ Blanking plate

JSY1000 series

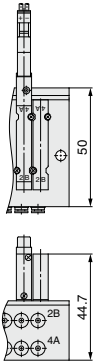

<Type 40>

JSY3000 series

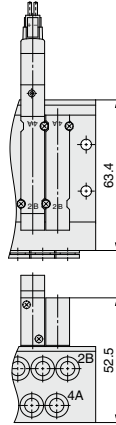

<Type 40>

JSY5000 series

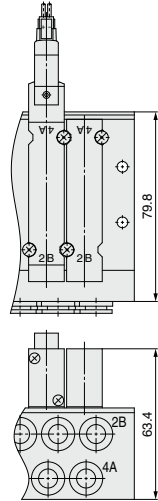

<Type 40>

■ Individual SUP/EXH spacer

JSY1000 series

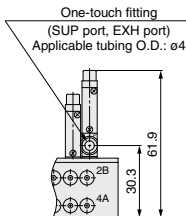
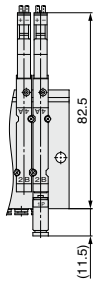

<Type 40>

JSY3000 series

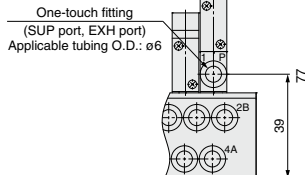
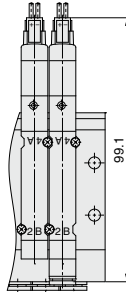

<Type 40>

JSY5000 series

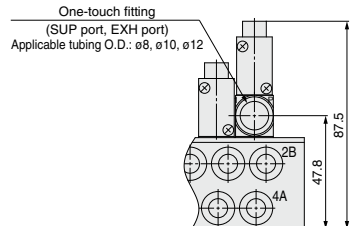
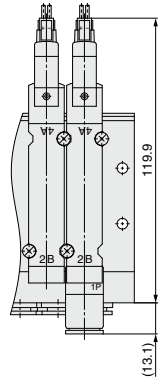

<Type 40>



1 External Pilot

How to Order Manifolds

p.178

JJ5SY $\frac{1}{3}$ - $\frac{40}{41}$ R - -

• Type

R External pilot

How to Order Valves

p.179

JSY 1 40 R T - 5

JSY $\frac{3}{5}$ 40 R - 5

• Coil type (See below.)

• Pilot type

R External pilot

* External pilot specification is not applicable for 4-position dual 3-port valves.

* When pilot type "R" is selected, select the external pilot type "R" for the manifold model.

2 Coil Type: With Power Saving Circuit (Continuous Duty Type)

Be sure to select the power saving circuit type when the JSY3000/5000 series is continuously energized for long periods of time.

Be careful of the energizing time when the power saving circuit is selected. Refer to page 207 for details.

0.1 W: JSY3000/5000

How to Order Valves

JSY $\frac{3}{5}$ 40 T - 5 Z

• Coil type

T With power saving circuit (Continuous duty type)

• Pilot type (See above.)

* M8 connector (WWA) with power saving circuit are not available.



JSY1000/3000/5000 Series Specific Product Precautions 1

Be sure to read this before handling the products.

Refer to page 7 for safety instructions and pages 8 to 14 for 3/4/5 port solenoid valve precautions.

Environment

⚠ Warning

Do not use valves in atmospheres of corrosive gases, chemicals, sea water, water, water vapor, or where there is direct contact with any of these.

Valve Mounting

⚠ Caution

Mount it so that there is no slippage or deformation in gaskets, and tighten with the tightening torque as shown below.

Series	Thread size	Tightening torque
JSY1000	M1.4	0.06 N·m
JSY3000	M2	0.16 N·m
JSY5000	M3	0.8 N·m

Manual Override

⚠ Warning

- Do not apply excessive torque when turning the manual override. [0.05 N·m]
When locking the manual override, be sure to push it down before turning. Turning without first pushing it down can cause damage to the manual override and other trouble such as air leakage, etc.
- Regardless of an electric signal for the valve, the manual override is used for switching the main valve. Connected actuator is started by manual operation. Use the manual override after confirming that there is no danger.

■ Non-locking push type

Push down on the manual override button until it stops.

JSY1000 series

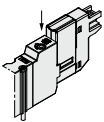

JSY3000/5000 series

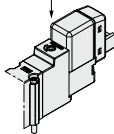

Manual Override

⚠ Warning

■ Push-turn locking slotted type [D type]

Push down on the manual override with a small flat head screwdriver until it stops, and then turn it 90° clockwise. The manual override is then locked. To release it, turn it counterclockwise.

If it is not turned, it can be operated the same way as the non-locking push type.

JSY1000 series

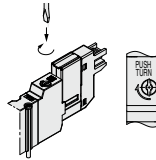

Locked position

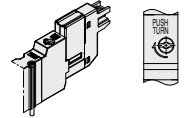

JSY3000/5000 series

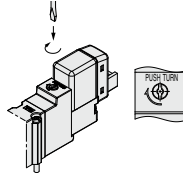

Locked position

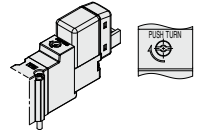

■ Push-turn locking lever type [E type]

Push down on the manual override by finger until it stops, and then turn it 90° clockwise. The manual override is then locked. To release it, turn it counterclockwise.

If it is not turned, it can be operated the same way as the non-locking push type.

JSY1000 series

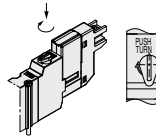

Locked position

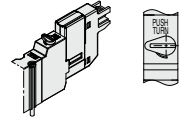

Carefully check the manual override projection amount.
Max. (at OFF): 3.2 mm

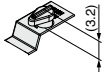

JSY3000/5000 series

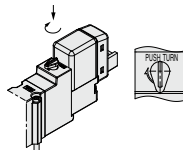

Locked position

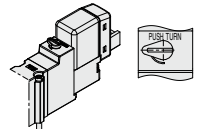

Carefully check the manual override projection amount.
Max. (at OFF): 3.2 mm

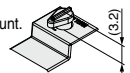



JSY1000/3000/5000 Series Specific Product Precautions 2

Be sure to read this before handling the products.

Refer to page 7 for safety instructions and pages 8 to 14 for 3/4/5 port solenoid valve precautions.

Used as a 3-Port Valve

⚠ Caution

■ In case of using a 5-port valve as a 3-port valve

The JSY1000/3000/5000 series can be used as normally closed (N.C.) or normally open (N.O.) 3-port valves by closing one of the cylinder ports 4(A) or 2(B) with a plug. However, they should be used with the exhaust ports kept open.

Plug position		B port	A port
Type of actuation		N.C.	N.O.
Number of solenoids	Single	(A)4 2(B) (EA)5 1 3(EB) (P)	(A)4 2(B) (EA)5 1 3(EB) (P)
	Double	(A)4 2(B) (EA)5 1 3(EB) (P)	(A)4 2(B) (EA)5 1 3(EB) (P)

How to Use L/M Plug Connector

⚠ Caution

1. Attaching and detaching connectors

- To attach a connector, hold the lever and connector unit between your fingers and insert straight onto the pins of the solenoid valve so that the lever's pawl is pushed into the groove and locks.
- To detach a connector, remove the pawl from the groove by pushing the lever downward with your thumb, and pull the connector straight out.

For JSY1000

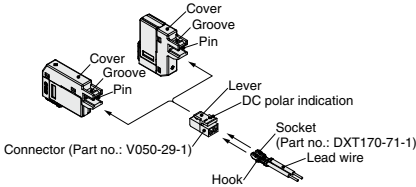

* In order not to damage the connector and cover, do not pull the lead wire excessively (with a force of 10 N or more).

For JSY3000/5000

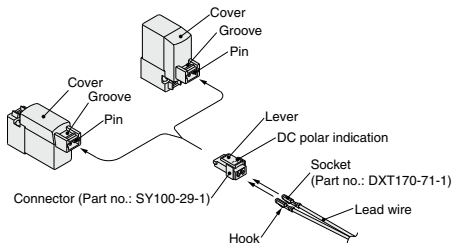

* In order not to damage the connector and cover, do not pull the lead wire excessively (with a force of 30 N or more).

How to Use L/M Plug Connector

⚠ Caution

2. Crimping connection of lead wire and socket

Strip 3.2 to 3.7 mm at the end of lead wires, insert the end of the core wires evenly into the sockets, and then crimp it by a crimping tool. When this is done, take care that the coverings of the lead wires do not enter the core wire crimping area. (Please contact SMC for the dedicated crimping tools.)

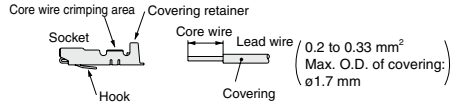

3. Attaching and detaching lead wires with sockets

● Attaching

Insert the sockets into the square holes of the connector (⊕, ⊖ indication), and continue to push the sockets all the way in until they lock by hooking into the seats in the connector.

(When they are pushed in, their hooks open and they are locked automatically.) Then confirm that they are locked by pulling lightly on the lead wires.

● Detaching

To detach a socket from a connector, pull out the lead wire while pressing the socket's hook with a stick having a thin tip (approx. 1 mm).

If the socket will be used again, first spread the hook outward.

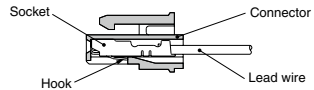



JSY1000/3000/5000 Series Specific Product Precautions 3

Be sure to read this before handling the products.

Refer to page 7 for safety instructions and pages 8 to 14 for 3/4/5 port solenoid valve precautions.

Plug Connector

<How to Order>

L/M Plug Connector

■ For JSY1000

V050-30-□ A-□

● Rated voltage

Symbol	Rated voltage	Lead wire color
4	DC	Red, Black
Nil	Without lead wire*1	

*1 With connector and 2 of sockets only

● Lead wire length

Symbol	Lead wire length
Nil	300 mm
6	600 mm
10	1000 mm
20	2000 mm
30	3000 mm
50	5000 mm

■ For JSY3000/5000

SY100-30-□ A-□

● Rated voltage

Symbol	Rated voltage	Lead wire color
4	DC	Red, Black
Nil	Without lead wire*1	

*1 With connector and 2 of sockets only

● Lead wire length

Symbol	Lead wire length
Nil	300 mm
6	600 mm
10	1000 mm
20	2000 mm
30	3000 mm
50	5000 mm

How to Order

Specify the plug connector part number together with the part number for the plug connector type solenoid valve without connector.

<Example> Lead wire length 2000 mm

For DC
JSY3140-5LOZ
SY100-30-4A-20

M8 Connector Type (JSY3000/5000)

■ Connector cable

- Connector cable for M8 can be ordered as follows:

How to Order

- To order solenoid valve and connector cable at the same time.
(Connector cable will be included in the shipment of the solenoid valve.)

JSY³₅ □ 40-5W □ 1 Z □

IEC Standards compliant

Symbol	IEC Standards compliant
Nil	None
A	IEC60947-2 compliant

● Cable length (mm)

Symbol	Cable length (mm)
1	300
2	500
3	1000
4	2000
5	3000
6	4000
7	5000

Ex. 1) Cable length: 300 mm

JSY3140-5W1Z

Symbol for electrical entry

- To order connector cable only

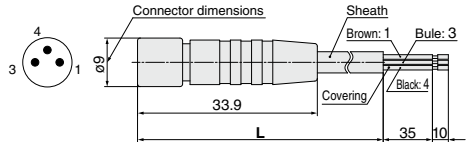

Cable length (L)	Part no.
300 mm	V100-49-1-1
500 mm	V100-49-1-2
1000 mm	V100-49-1-3
2000 mm	V100-49-1-4
5000 mm	V100-49-1-7
3000 mm	V100-49-1-5
4000 mm	V100-49-1-6

Sheath O.D.	ø3.4 mm
Cover diameter	ø1.16 mm
Conductor area	0.16 mm ²

[Dimensions when installed]

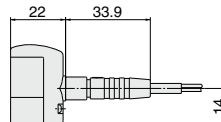



JSY1000/3000/5000 Series Specific Product Precautions 4

Be sure to read this before handling the products.

Refer to page 7 for safety instructions and pages 8 to 14 for 3/4/5 port solenoid valve precautions.

Surge Voltage Suppressor

⚠ Caution

<For DC>

L/M Plug Connector

■ Polar type (For JSY3000/5000)

With light/surge voltage suppressor (□Z)

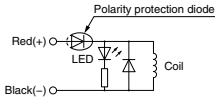

- Connect in accordance with the +, - polarity indication.
- When wiring is done at the factory, positive (+) is red and negative (-) is black.

■ With power saving circuit (JSY3000/5000: Made to Order)

Power consumption is decreased to approx. 1/2.5 to 1/4 of the amount consumed at startup by reducing the wattage required to hold the valve in an energized state. (Effective energizing time is over 62 ms at 24 VDC.)

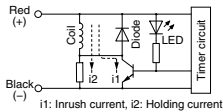

The circuit shown above reduces the power consumption for holding in order to save energy. Refer to the electrical power waveform as shown below.

<Electrical power waveform with power saving circuit>

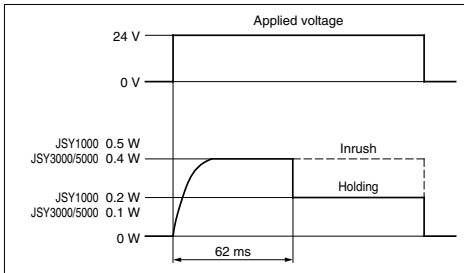

- Be careful not to reverse the polarity, since a diode to prevent the reversed current is not provided for the power saving circuit.
- Since the voltage will drop by approx. 0.5 V due to the transistor, pay attention to the allowable voltage fluctuation. (For details, refer to the solenoid specifications of each type of valve.)

M8 Connector Type (JSY3000/5000)

■ Polar type

With surge voltage suppressor (□S)

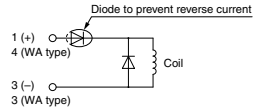

With light/surge voltage suppressor (□Z)

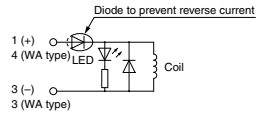

Solenoid valve side pin wiring diagram

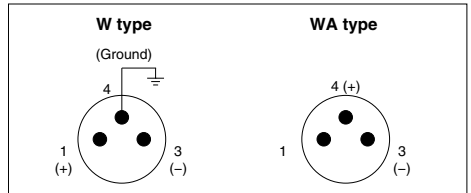

* The WA-type valve cannot be grounded.



JSY1000/3000/5000 Series Specific Product Precautions 5

Be sure to read this before handling the products.

Refer to page 7 for safety instructions and pages 8 to 14 for 3/4/5 port solenoid valve precautions.

Continuous Duty

⚠ Caution

If a valve is energized continuously for long periods of time, the rise in temperature due to heat-up of the coil assembly may cause a decline in solenoid valve performance, reduce service life, or have adverse effects on peripheral equipment. If the valve is energized continuously for long periods of time, be sure to use a valve with power saving circuit. In particular, if three or more adjacent stations on the manifold are energized simultaneously for extended periods of time or if the valves on A side and B side are energized simultaneously for long periods of time, take special care as the temperature rise will be greater.

Energization of a 2-Position Double Solenoid Valve

⚠ Caution

To avoid operation failure, do not energize the A side and B side of 2-position double solenoid valve at the same time.

How to Replace One-touch Fittings

⚠ Caution

By replacing One-touch fittings of manifold base, it is possible to change the connection diameter of the 4(A), 2(B), 1(P), 3/5(E) ports. When replacing the One-touch fittings, remove the clip or the plate before pulling the One-touch fittings off. Mount the One-touch fittings by following the removal procedure in reverse. Use caution as it may cause air leakage if the clip and the plate are not inserted securely enough when they are switched. Refer to page 199 for part numbers of One-touch fittings.

Fitting direction is specified when the fittings below are used. Assemble the fitting so that the D-cut surfaces of the fitting face sideways.

Fitting part no.: KQSY10-C4-X1336 (JSY1000)
KQSY11-C6-X1336 (JSY1000)
KQSY30-C8-X1336 (JSY3000)
KQSY50-C12-X1336 (JSY5000)

■ Metal base

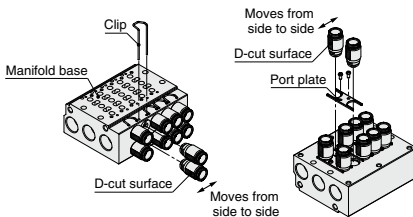

- * It is not possible to replace C2 or C4 fittings with C6 fittings for the JSY1000 series.
- * Refer to page 199 for One-touch fitting, clip, and port plate part numbers.

One-touch Fittings

⚠ Caution

■ Tube attachment/detachment for One-touch fittings

1) Tube attachment

1. Take a tube having no flaws on its periphery and cut it off at a right angle. When cutting the tube, use tube cutters TK-1, 2 or 3. Do not use pliers, nippers or scissors, etc. If cutting is done with tools other than tube cutters, the tube may be cut diagonally or become flattened, etc., making a secure installation impossible, and causing problems such as the tube pulling out after installation or air leakage. Allow some extra length in the tube.
2. Grasp the tube and push it in slowly, inserting it securely all the way into the fitting.
3. After inserting the tube, pull on it lightly to confirm that it will not come out. If it is not installed securely all the way into the fitting, this can cause problems such as air leakage or the tube pulling out.

2) Tube detachment

1. Push in the release button sufficiently, pushing its collar equally around the circumference.
2. Pull out the tube while holding down the release button so that it does not come out. If the release button is not pressed down sufficiently, there will be increased bite on the tube and it will become more difficult to pull it out.
3. When the removed tube is to be used again, cut off the portion which has been chewed before reusing it. If the chewed portion of the tube is used as is, this can cause trouble such as air leakage or difficulty in removing the tube.

Applicable Fittings: KQ2H, KQ2S, M Series

Series	Model	Piping port	Port size	Fitting	Applicable tubing O.D.					
					ø2	ø4	ø6	ø8	ø10	ø12
JSY1000	JJSY1-40/41(R) Manifold base	1P, 5EA 3EB	1/8	KQ2H						
				KQ2S						
		X, PE	M5	KQ2H						
				KQ2S						
		4A, 2B	M5	KQ2H						
				KQ2S						
M3	KQ2H									
	KQ2S									

Series	Model	Piping port	Port size	Fitting	Applicable tubing O.D.					
					ø2	ø4	ø6	ø8	ø10	ø12
JSY3000	JJSY3-40/41(R) Manifold base	1P, 5EA 3EB	1/4	KQ2H						
				KQ2S						
		X, PE	M5	KQ2H						
				KQ2S						
		4A, 2B	1/8	KQ2H						
				KQ2S						
M5	KQ2H									
	KQ2S									

Series	Model	Piping port	Port size	Fitting	Applicable tubing O.D.					
					ø2	ø4	ø6	ø8	ø10	ø12
JSY5000	JJSY5-40/41(R) Manifold base	1P, 5EA 3EB	3/8	KQ2H						
				KQ2S						
		X, PE	M5	KQ2H						
				KQ2S						
		4A, 2B	1/4	KQ2H						
				KQ2S						
1/8	KQ2H									
	KQ2S									



JSY1000/3000/5000 Series Specific Product Precautions 6

Be sure to read this before handling the products.

Refer to page 7 for safety instructions and pages 8 to 14 for 3/4/5 port solenoid valve precautions.

Other Tube Brands

⚠ Caution

1. When using other than SMC brand tube, confirm that the following specifications are satisfied with respect to the tube outside diameter tolerance.

1) Nylon tube	within ± 0.1 mm
2) Soft nylon tube	within ± 0.1 mm
3) Polyurethane tube	within $+0.15$ mm within -0.2 mm

Do not use tube which do not meet these outside diameter tolerances. It may not be possible to connect them, or they may cause other trouble, such as air leakage or the tube pulling out after connection.

Fixation of DIN Rail Mounting Type Manifolds

⚠ Caution

1. When the manifold is fixed with bolts on a mounting surface etc., it can be operated just by fixing on both ends of the DIN rail if the bottom surface of the DIN rail is entirely in contact with the mounting surface when mounted horizontally. However, if it is used with other mounting or with side or reverse mounting, fix the DIN rail with bolts at regular intervals. As a guide, insert bolts in 2 locations for 2-5 stations, 3 locations for 6-10 stations, 4 locations for 11-15 stations, and 5 locations for 16-20 stations.
2. When using the manifold with DIN rail in an environment where any vibration or impact is applied to it, the DIN rail itself may be broken. In particular, if the installation surface vibrates when mounting the manifold on the wall or if a load is directly applied to the manifold, the DIN rail may be broken, causing the manifold to drop. When any vibration, impact, or load is applied to the manifold, be sure to use the direct mounting manifold.

M8 Connector

⚠ Caution

1. M8 connector types have an IP65 (enclosure) rating, offering protection from dust and water. However please note: these products are not intended for use in water. Select a SMC connector cable (V100-49-1-□) or a FA sensor type connector, with M8 threaded 3 pin specifications conforming to Nippon Electric Control Equipment Association Standard, NECA4202 (IEC60947-5-2). Make sure the connector O.D. is 10.5mm or less when used with the JSY3000 series manifold. If more than 10.5mm, it cannot be mounted due to the size.
2. Do not use a tool to mount the connector, as this may cause damage. Only tighten by hand. (0.4 to 0.6 N-m)
3. The excessive stress on the cable connector will not be able to satisfy the IP65 rating. Please use caution and do not apply a stress of 30 N or greater.

⚠ Caution

Failure to meet IP65 performance may result if using alternative connectors than those shown above, or when insufficiently tightened.

Connector cable mounting



- * Connector cable should be mounted in the correct direction. Make sure that the arrow symbol on the connector is facing the triangle symbol on the valve when using SMC connector cable (V100-49-1-□). Be careful not to squeeze it in the wrong direction, as problems such as pin damage may occur.

Installation

⚠ Caution

Even though the inlet pressure is within the operating pressure range, when the piping diameter is restricted due to size reduction of supply port (P), the flow will be insufficient. In this case, the valve does not switch completely and the cylinder may malfunction.

Compact 5-Port Solenoid Valve

JSY1000/3000/5000 Series

Non Plug-in

Body Ported

Single Unit (For Mounting P.E Plate)



Wall mounting is possible.

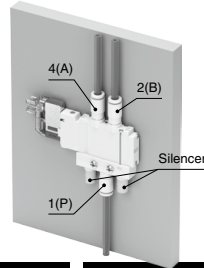

*1 The cylinder speed is 300 mm/s.

The valve size can be reduced.

This allows for space saving and weight reduction.

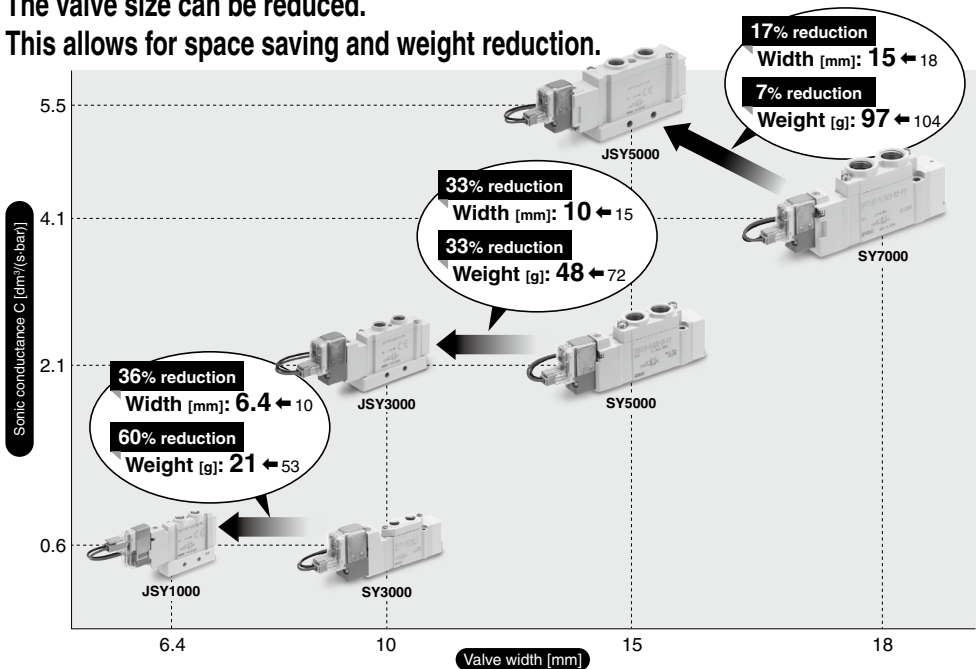

JSY1000/3000/5000 Series Valve Specifications

Valve Specifications

Valve type			Rubber seal
Fluid			Air
Internal pilot operating pressure range [MPa]	2-position single		0.15 to 0.7
	2-position double		0.1 to 0.7
Ambient and fluid temperatures [°C]			-10 to 50 (No freezing)
Max. operating frequency [Hz]	JSY1000	2-position single/double	5
	JSY3000		
	JSY5000	2-position single/double	5
Manual override			Non-locking push type Push-turn locking slotted type Push-turn locking lever type
Pilot exhaust type	Internal pilot		Individual exhaust
Lubrication			Not required
Mounting orientation*1			Unrestricted
Impact/Vibration resistance*1 [m/s ²]			150/30
Enclosure			IP40
Electrical entry			L plug connector (L), M plug connector (M)
Coil rated voltage [V]			24 VDC
Allowable voltage fluctuation			JSY1000
			JSY3000/5000
Power consumption [W]			-7% to +10% of the rated voltage (24 VDC)
DC	Standard	JSY3000/5000	±10% of rated voltage
		JSY1000	0.4
	With power-saving circuit	JSY1000	0.2*2 [Inrush: 0.5, Holding: 0.2]
		JSY3000/5000 (Made to Order)	0.1 [Inrush: 0.4, Holding: 0.1]
Surge voltage suppressor			Diode
Indicator light			LED

*1 Impact resistance: No malfunction occurred when tested in the axial direction and at a right angle to the main valve and armature in both an energized and a de-energized state, once in each condition. (Value in the initial state)

Vibration resistance: No malfunction occurred in a one-sweep test between 45 and 2000 Hz. Test was performed at both an energized and a de-energized state in the axial direction and at a right angle to the main valve and armature. (Value in the initial state)

*2 JSY1000 series available as power-saving type only. Standard type (without power-saving circuit) cannot be selected.

Response Time/Valve Weight

Body Ported

Series	Seal type	Model	Type of actuation	Response time [ms] (at 0.5 MPa)*1		Valve weight [g]
				Standard		
				With light/surge voltage suppressor		
				Z type		
JSY1000	Rubber seal	JSY1120T	2-position single	15		21
		JSY1220T	2-position double	5		28
JSY3000		JSY3120	2-position single	27		48
		JSY3220	2-position double	10		63
JSY5000		JSY5120	2-position single	42		97
		JSY5220	2-position double	13		113

*1 Based on the JIS B 8419: 2010 dynamic performance test (Coil temperature 20°C, at rated voltage)

JSY1000/3000/5000 Series Type 20

Non Plug-in Body Ported Single Unit (For Mounting P.E Plate)

Single Unit Specifications



Model		Non plug-in, For mounting P.E plate	
Port size	1(P), 3/5(E) port	JSY1000	M5 x 0.8
		JSY3000	1/16
		JSY5000	1/8
	4(A), 2(B) port	JSY1000	M3 x 0.5, M5 x 0.8
		JSY3000	1/16
		JSY5000	1/8

Flow Rate Characteristics

Model	Port size		Valve flow rate characteristics			
	1, 5, 3 (P, EA, EB)	4, 2 (A, B)	1 → 4/2 (P → A/B)		4/2 → 5/3 (A/B → E)	
			C [dm ³ /(s·bar)]	b	C [dm ³ /(s·bar)]	b
JSY1000	M5	M5	0.6	0.48	0.6	0.39
JSY3000	1/16	1/16	2.0	0.41	2.1	0.35
JSY5000	1/8	1/8	5.5	0.38	5.4	0.36

* Calculation of effective area S and sonic conductance C: $S = 5.0 \times C$

Non Plug-in Body Ported

Single Unit (For Mounting P.E Plate)

JSY1000/3000/5000 Series



Type 20
Top Ported

How to Order Valves

JSY1000

JSY 1 1 20 T - 5 L Z □ - M3 - PE

JSY3000/5000

JSY 3 1 20 - 5 L Z □ - R1 - PE

1 2 3

4 5 6 7

8 9

Body ported

With power-saving circuit

1 Series

1	JSY1000
3	JSY3000
5	JSY5000

2 Type of actuation

1	2-position single
2	2-position double

3 Body option

0	Pilot valve exhaust method
---	----------------------------

4 Rated voltage

5	24 VDC
---	--------

5 Electrical entry

	L plug connector		M plug connector	
	L	LO	M	MO
JSY1000	L: With lead wire (300 mm) 	LO: Without connector 	M: With lead wire (300 mm) 	MO: Without connector
JSY3000 JSY5000	L: With lead wire (300 mm) 	LO: Without connector 	M: With lead wire (300 mm) 	MO: Without connector

* Refer to the **Web Catalog** for the lead wire lengths of "L" and "M" plug connectors.

6 Light/surge voltage suppressor and common specifications

Z	With light/surge voltage suppressor
---	-------------------------------------

7 Manual override

JSY1000	Nil: Non-locking push type 	D: Push-turn locking slotted type 	E: Push-turn locking lever type
JSY3000 JSY5000	Nil: Non-locking push type 	D: Push-turn locking slotted type 	E: Push-turn locking lever type

8 4(A)/2(B) port size thread piping

Symbol	Thread piping	JSY1000	JSY3000	JSY5000
M3	M3 x 0.5	●	—	—
M5	M5 x 0.8	●	—	—
R1	Rc1/16	—	●	—
01	Rc1/8	—	—	●

9 With P.E plate

Symbol	Port size	JSY1000	JSY3000	JSY5000
PE	M5	●	—	—
	Rc1/16	—	●	—
	Rc1/8	—	—	●

Caution

If the JSY3000/5000 series is to be continuously energized, please be sure to select the power-saving circuit (continuous duty type) specification. Refer to "Made to Order" on page 222.

Additionally, if it is to be used at an energizing rate of over 50%, please select the product with a power-saving circuit. For the JSY1000 series, only the power-saving circuit specification is available.



Made to Order
(Refer to page 222 for details.)

Specification

With power-saving circuit
(Continuous duty type):
0.1 W (JSY3000/5000)

Caution

Refer to the following to order the fitting/silencer for the 1/16 thread piping of the JSY3000 separately.

Description	Part number	Port size Piping/Type
One-touch fittings (Applicable tubing O.D.: ø6)	KQ2S06-R1AS-X1517*1	Rc1/16
One-touch fittings (Applicable tubing O.D.: ø8)	KQSY-S08R1S*1	
Silencer	INA-25-98	

*1 The part number is for 1 piece. (Sales unit: 10 pcs.)

*1 Tightening torque: 2 to 3 N·m (One-touch fitting)

Dimensions: JSY1000 Series

Body Ported	Type 20/Top Ported
Single Unit	Port Size: M3, M5



2-position single/L plug connector (L) JSY1120T-5LZ□-M5-PE

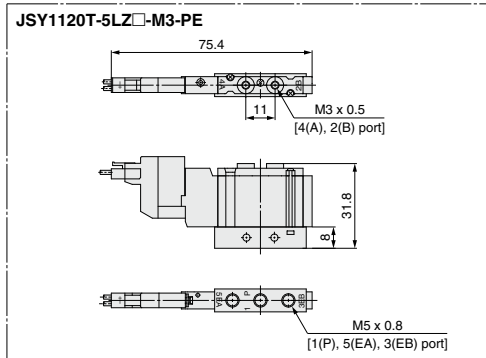
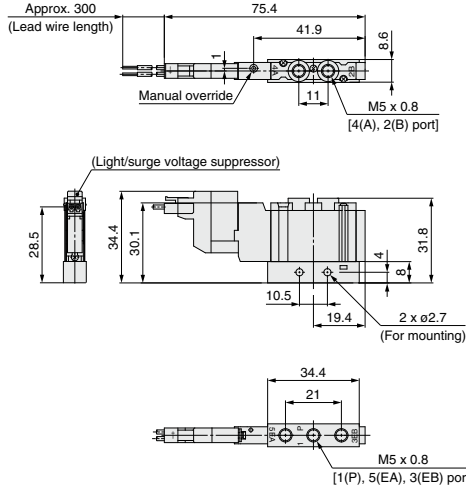

M plug connector (M) JSY1120T-5MZ□-M5-PE

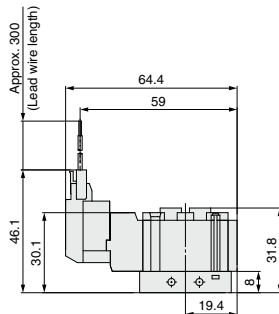

JSY1000/3000/5000 Series

Body Ported	Type 20/Top Ported
Single Unit	Port Size: M3, M5

Dimensions: JSY1000 Series



2-position double/L plug connector (L) JSY1220T-5LZ□-M5-PE

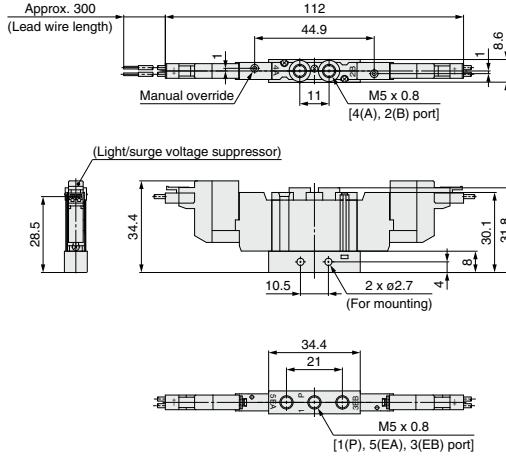

JSY1220T-5LZ□-M3-PE

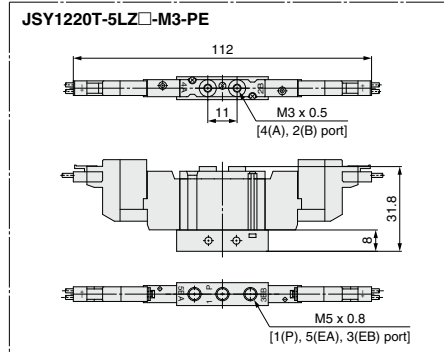

M plug connector (M) JSY1220T-5MZ□-M5-PE

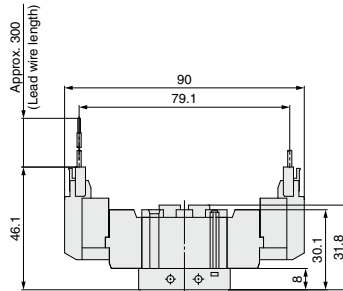

Dimensions: JSY3000 Series

Body Ported	Type 20/Top Ported
Single Unit	Port Size: Rc1/16



2-position single/L plug connector (L) JSY3120-5LZ□-R1-PE

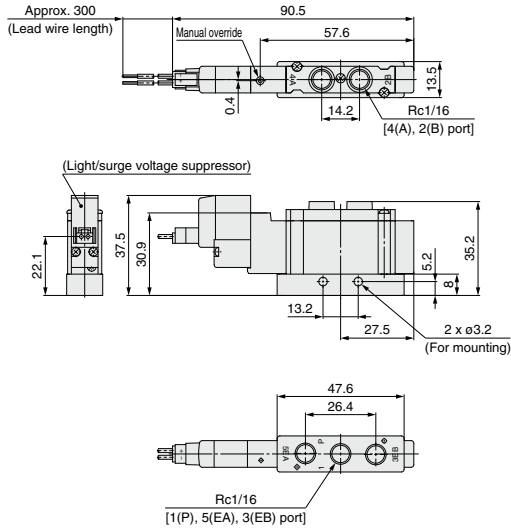

M plug connector (M) JSY3120-5MZ□-R1-PE

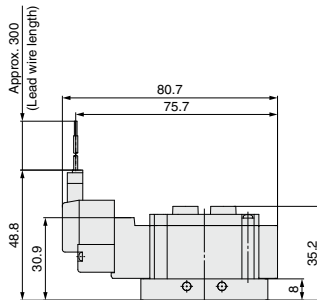

JSY1000/3000/5000 Series

Dimensions: **JSY3000 Series**

Body Ported	Type 20/Top Ported
Single Unit	Port Size: Rc1/16



2-position double/L plug connector (L)

JSY3220-5LZ□-R1-PE

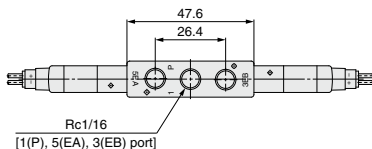
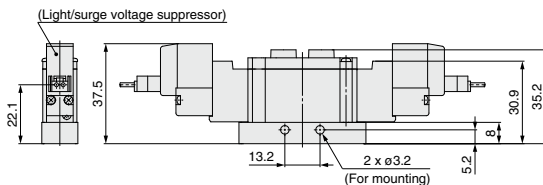
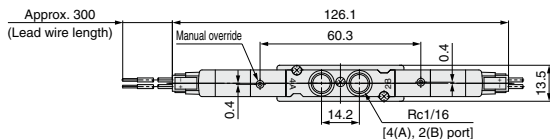

M plug connector (M)

JSY3220-5MZ□-R1-PE

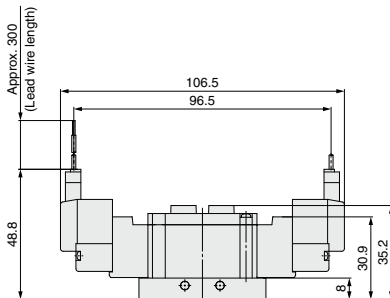

Dimensions: JSY5000 Series

Body Ported Type 20/Top Ported
Single Unit Port Size: Rc1/8



2-position single/L plug connector (L) JSY5120-5LZ□-01-PE

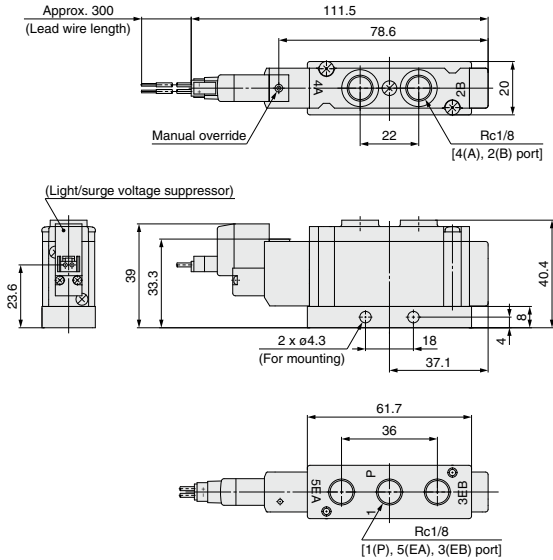

M plug connector (M) JSY5120-5MZ□-01-PE

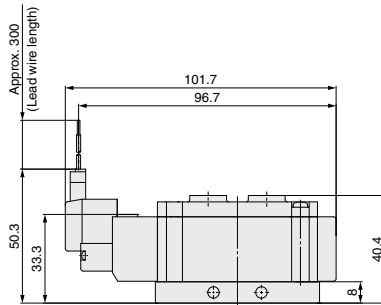

JSY1000/3000/5000 Series

Dimensions: **JSY5000 Series**

Body Ported	Type 20/Top Ported
Single Unit	Port Size: Rc1/8



2-position double/L plug connector (L)
JSY5220-5LZ□-01-PE

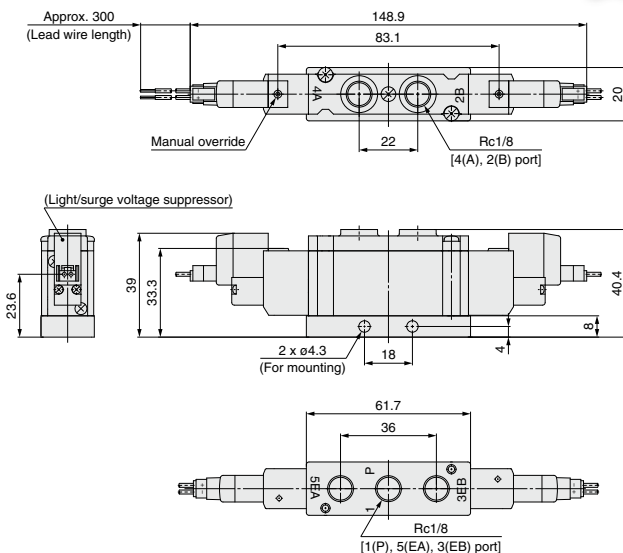

M plug connector (M)
JSY5220-5MZ□-01-PE

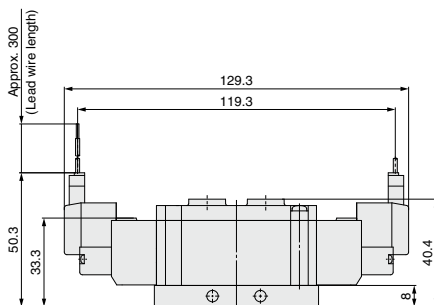

JSY1000/3000/5000 Series

Non Plug-in Single Unit Parts Nos.

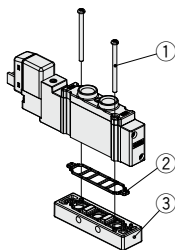

No.	Description	Part number			Note
		JSY1000	JSY3000	JSY5000	
①	Valve mounting screw	JSY11V-23-3A (M1.4 x 24.5)	JSY31V-23-7A (M2 x 27)	JSY51V-23-7A (M3 x 32)	Part numbers shown on the left are for 10 valves. (20 pcs.)
②	Base gasket	JSY11M-9P-1A	JSY31M-9P-1A	JSY51M-9P-1A	Part numbers shown on the left are for 10 valves. (10 pcs.)
③	P.E plate assembly	JSY11V-7A-M5	JSY31V-7A-R1	JSY51V-7A-01	With base gasket Available in units of 1 set For details, refer to the part numbers below.

■ P.E Plate

JSY **3** 1V-7A-**R1**

①

②

① Series

1	JSY1000
3	JSY3000
5	JSY5000

② Thread piping

Symbol	Thread piping	JSY1000	JSY3000	JSY5000
M5	M5 x 0.8	●	—	—
R1	Rc1/16	—	●	—
01	Rc1/8	—	—	●

JSY1000/3000/5000 Series

Made to Order

Please contact SMC for detailed dimensions, specifications, and delivery times.



1 Coil type: With power-saving circuit (Continuous duty type)

Be sure to select the power-saving circuit type when the JSY3000/5000 series is continuously energized for long periods of time.
Be careful of the energizing time when the power-saving circuit is selected.

0.1 W: JSY3000/5000

How to Order Valves

JSY $\frac{3}{5}$ □ 20 T - 5 □ Z □ - □ - PE

● Coil type

T With power-saving circuit (Continuous duty type)